

Teniatown Project

spring 2023

Diagram

Relation Between site & villas

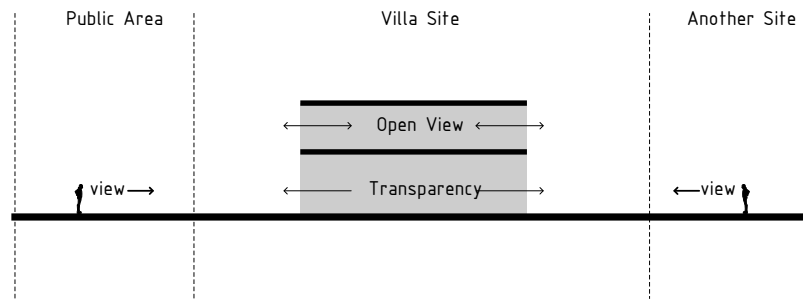
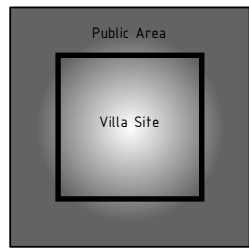

Relations Between PUBLIC and VILLA SITE

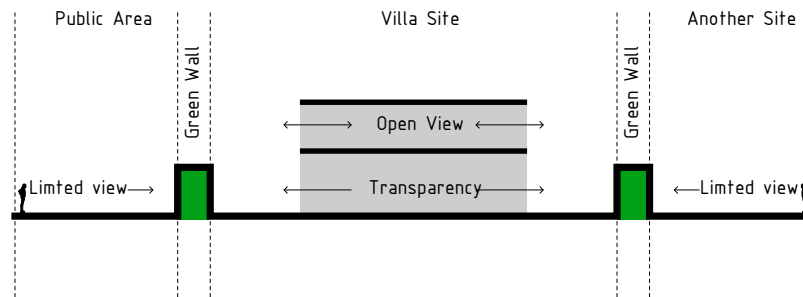
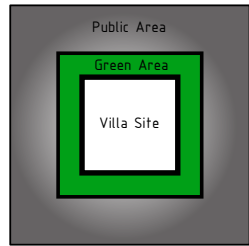

GREEN WALL

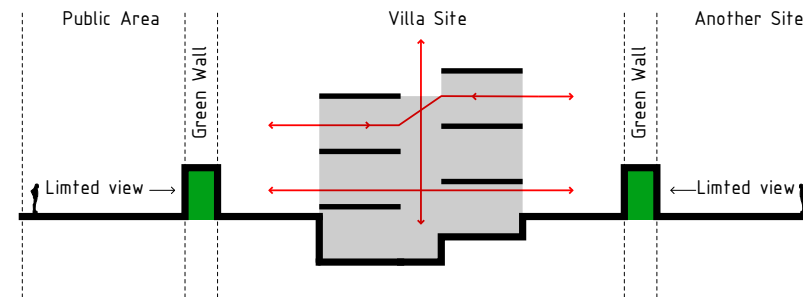

CREAT Half Floor

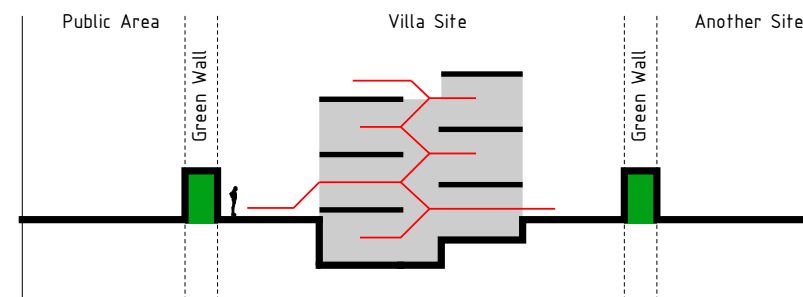

CREAT NEW VIEW

Mass & Empty

Mass

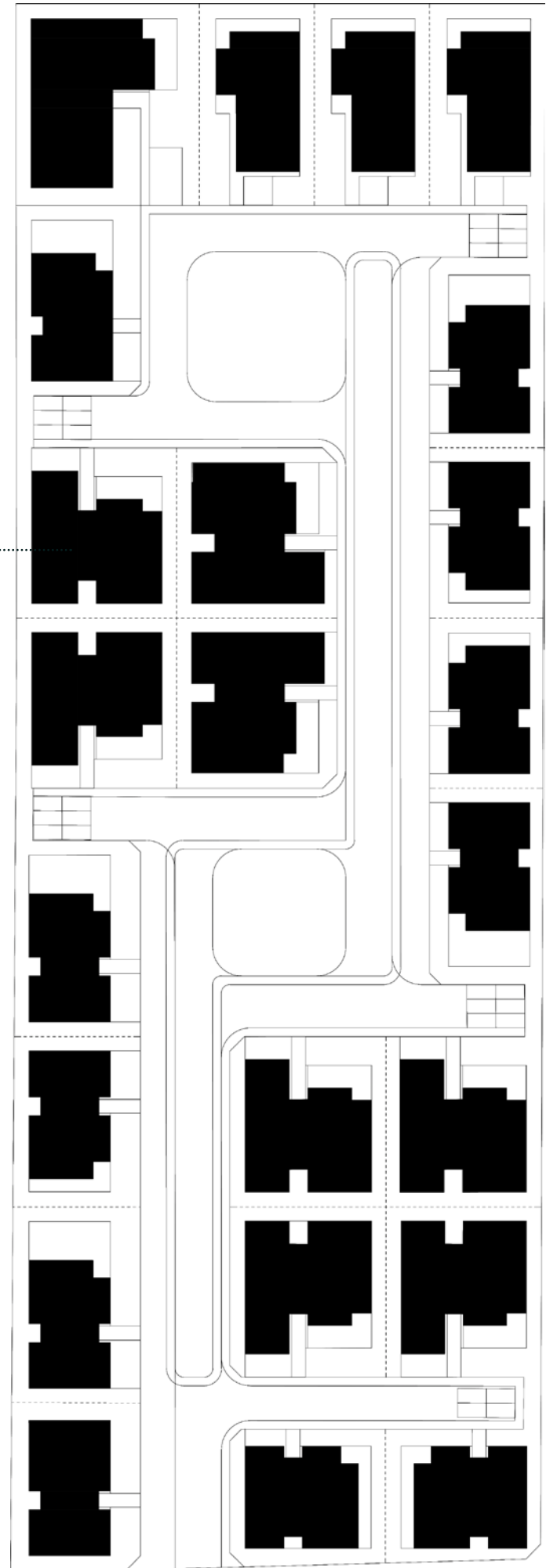

Green Space

Mass

Green Space

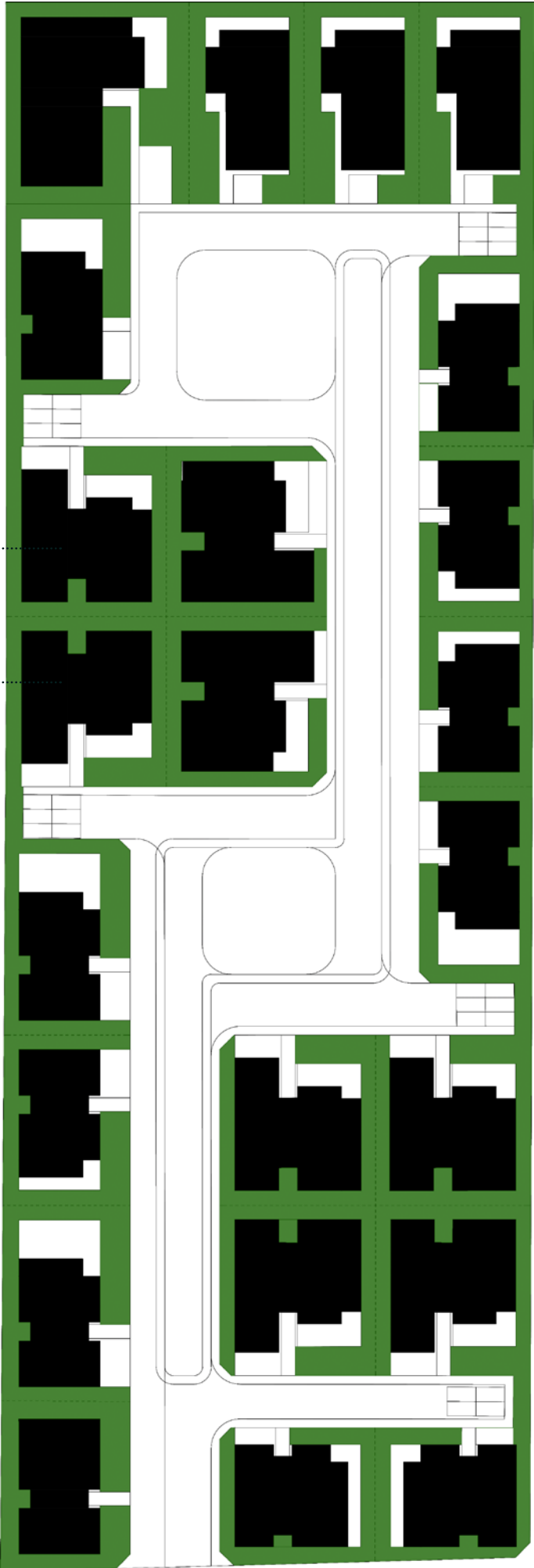

Focal Point

Focal Point

Mass

Green Space

Focal Point

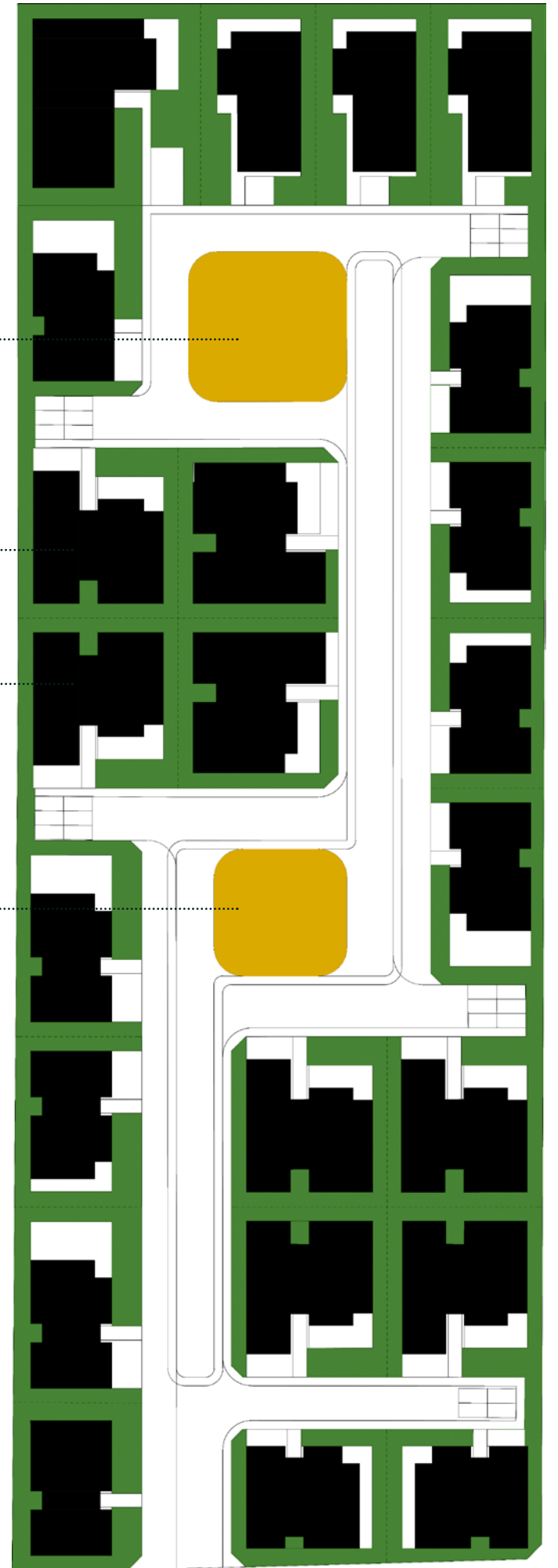

Health Road | Green line

Focal Point

Health Road | Green line

Mass

Green Space

Focal Point

Health Road | Green line

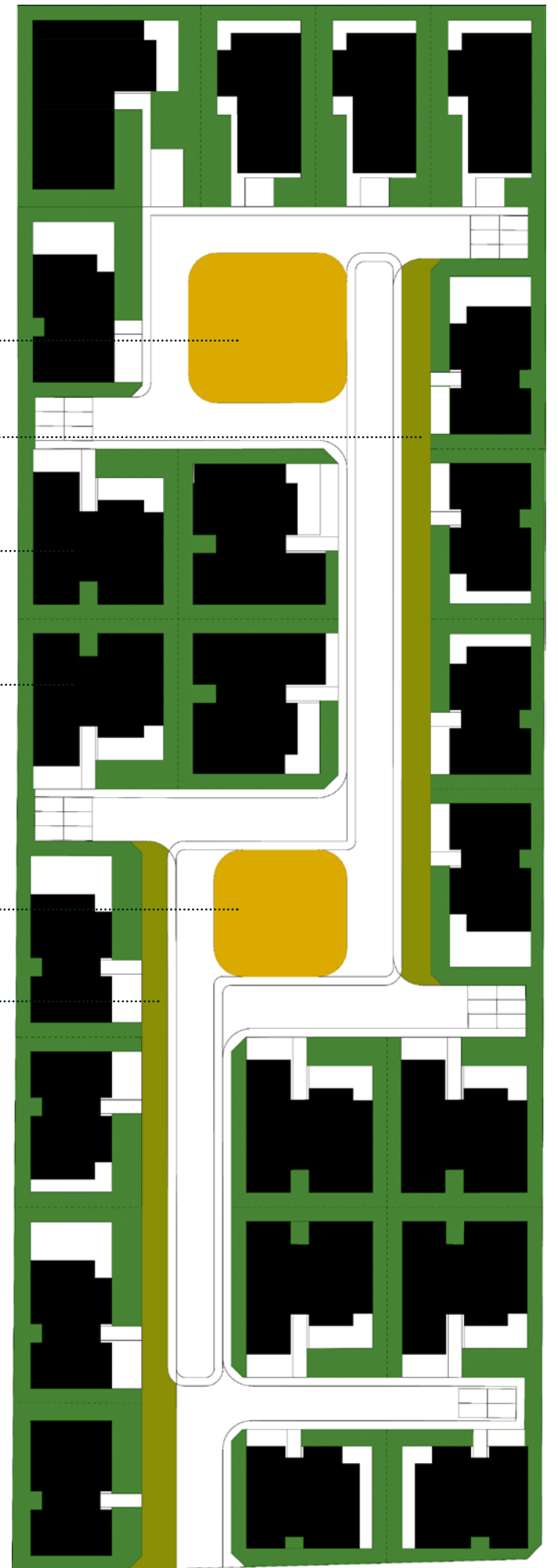

Bicycle Road

Bicycle Road

Focal Point

Health Road | Green line

Mass

Green Space

Focal Point

Health Road | Green line

Bicycle Road

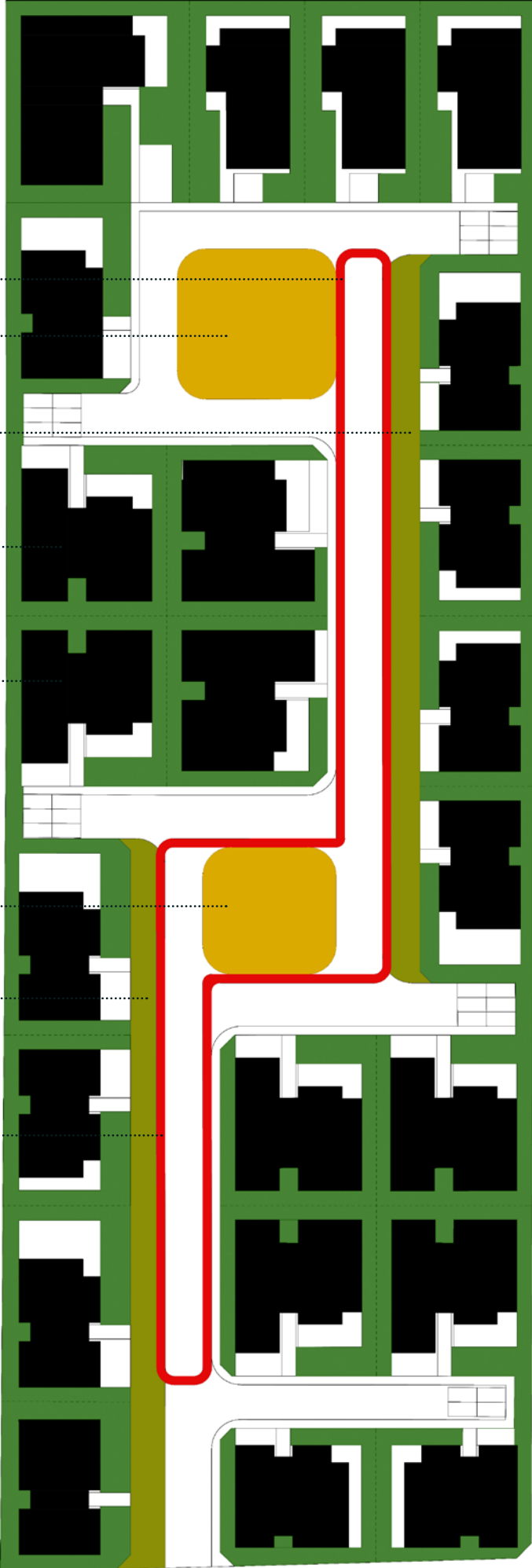

Villa Diagram

1

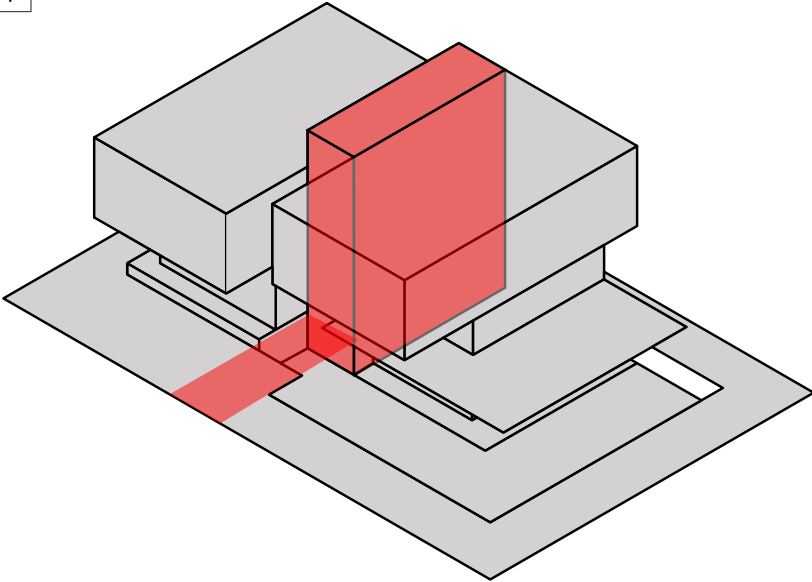

Relations Between BUILDING AND SITE

2

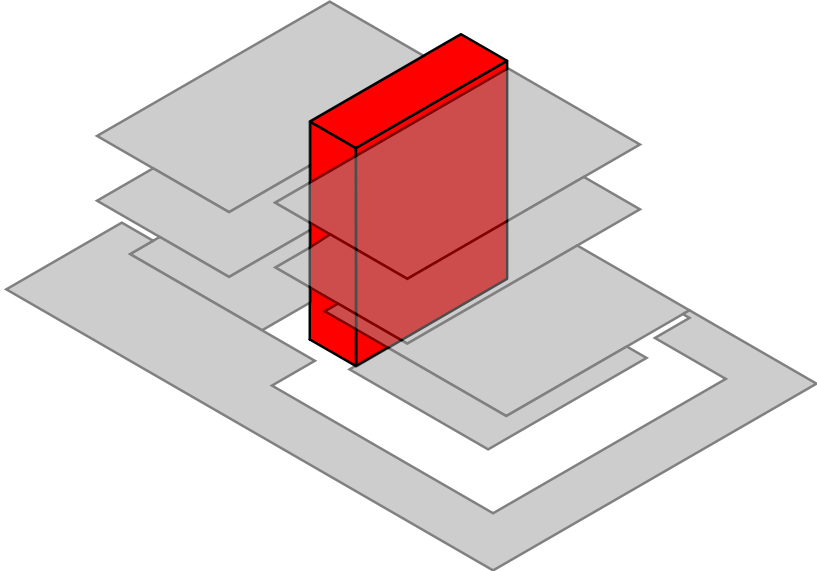

Relations Between STAIR BOX & LEVEL

3

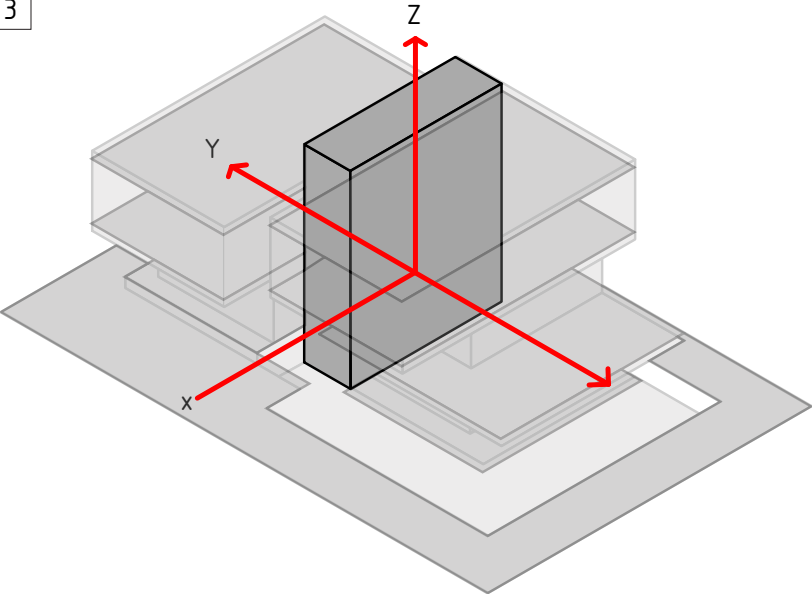

CREAT NEW VIEW

4

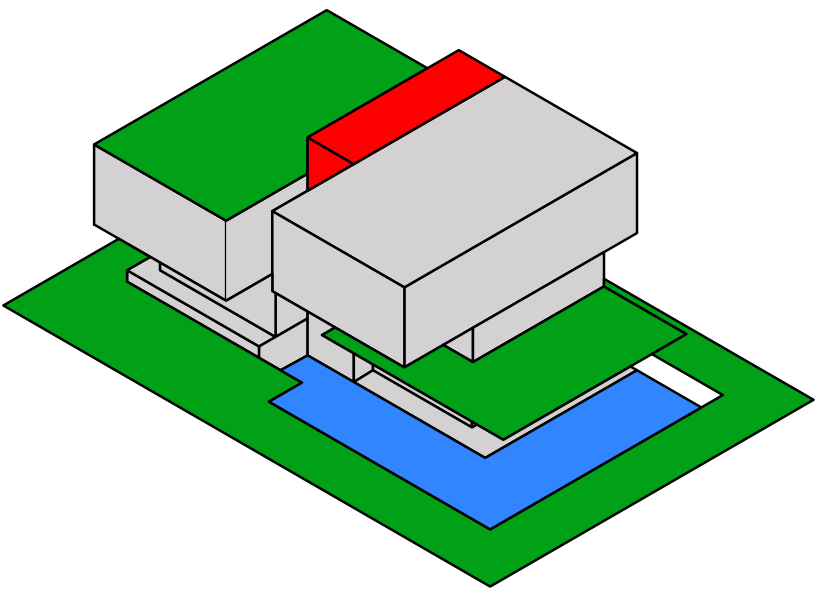

Roof Space

Villa Formation

1

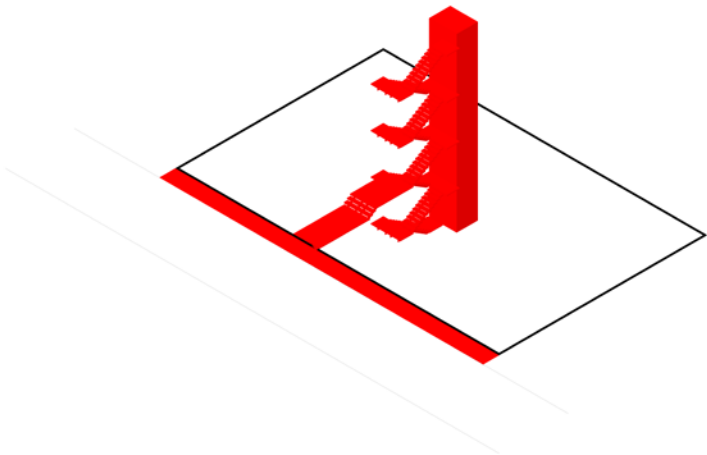

2

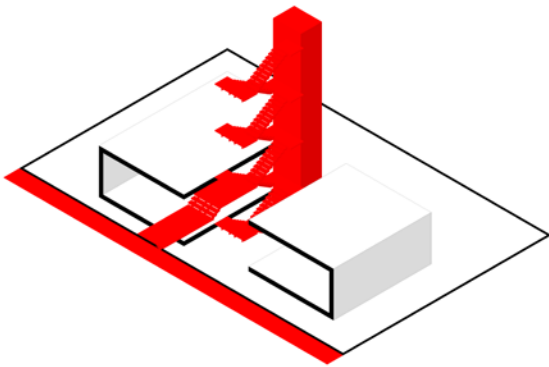

3

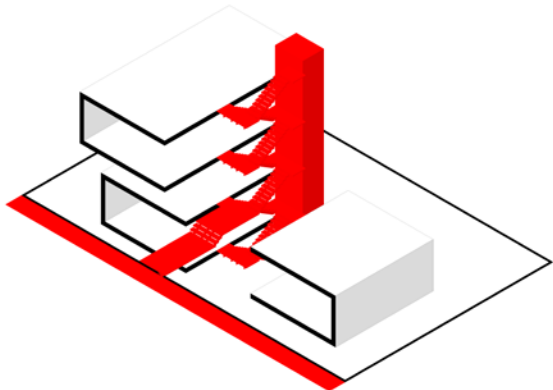

4

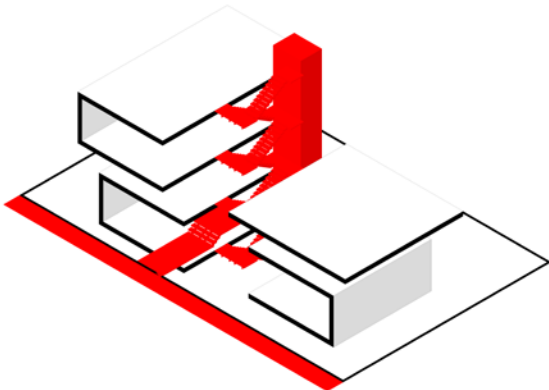

5

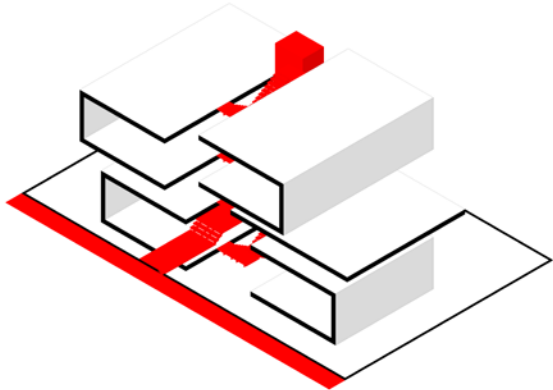

6

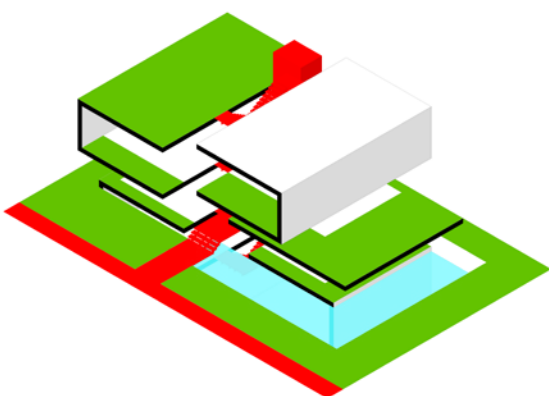

Image





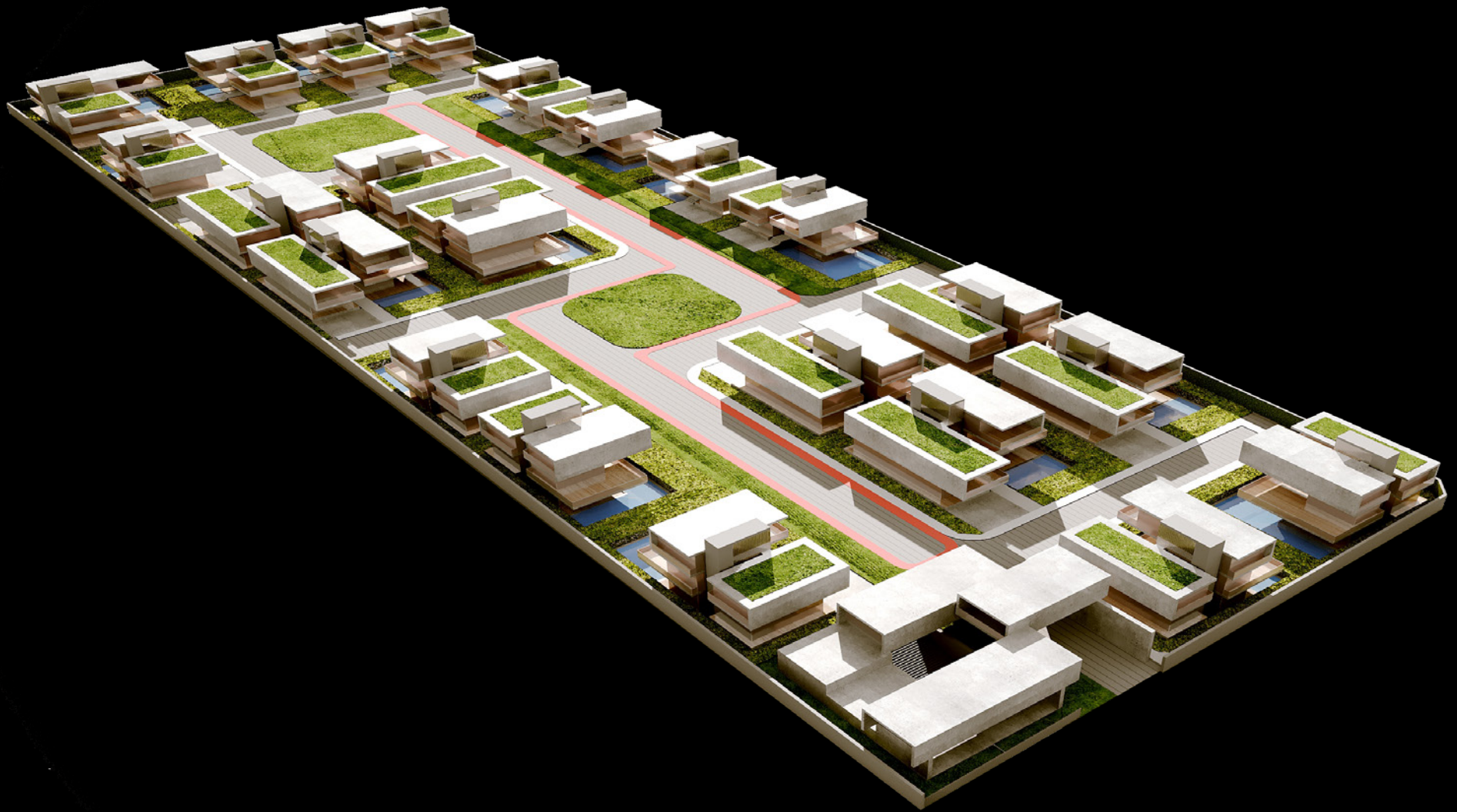





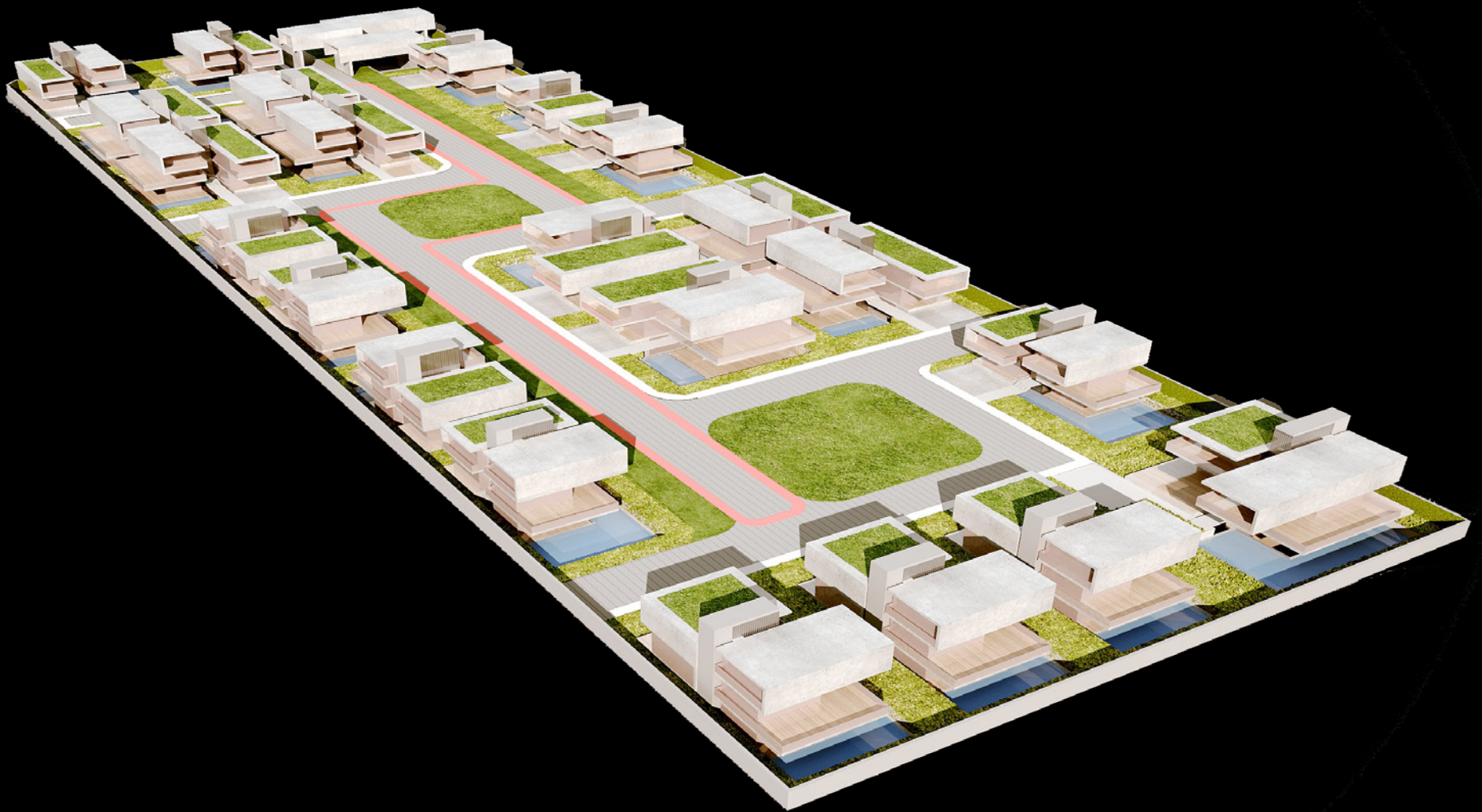





Villas type

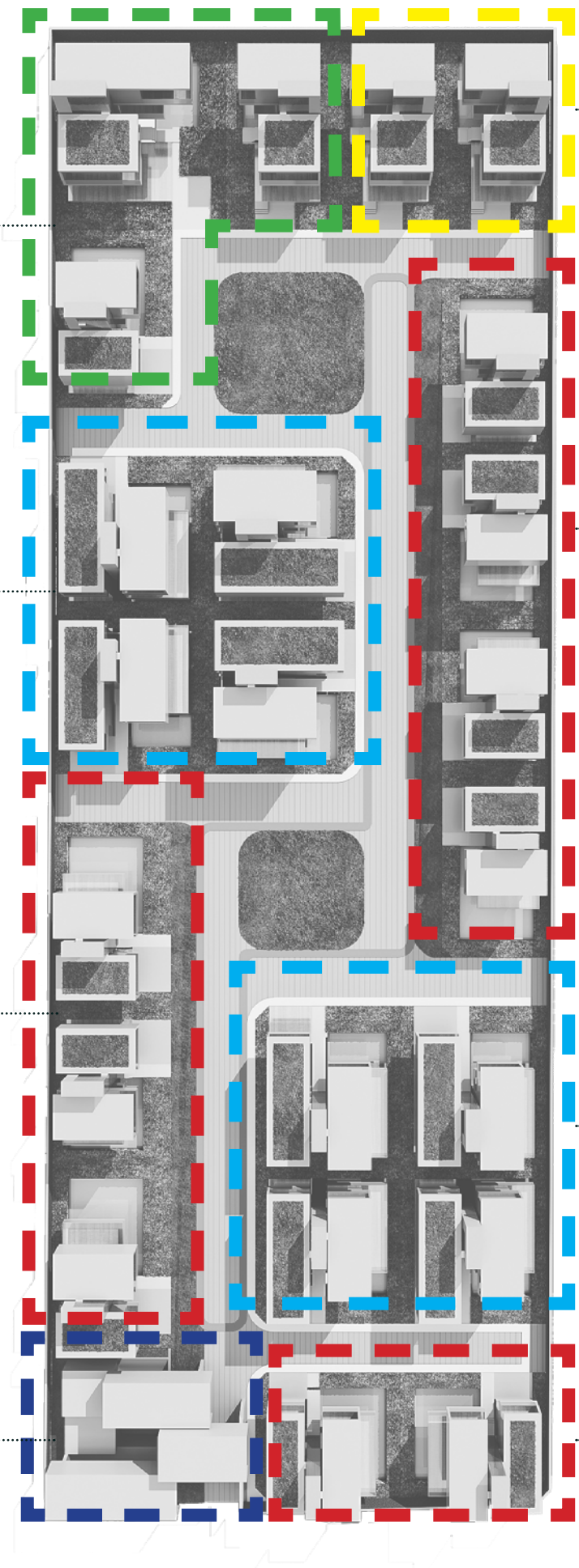

type 4

type 3

type 2

type 1

type 1

type 2

gate & public building

type 1

type 1



type 2



type 3



type 4



gate & public building

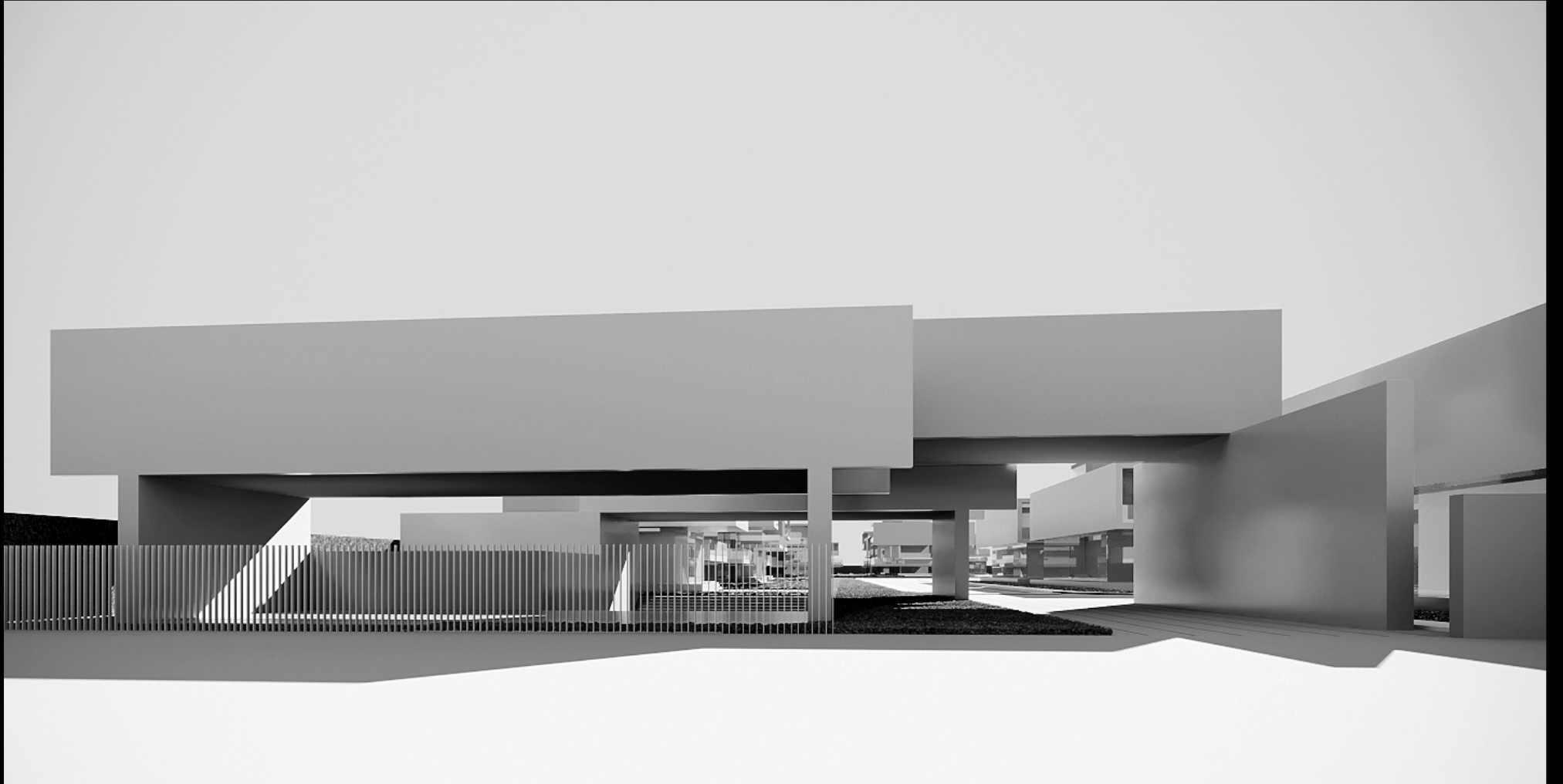

gate & public building

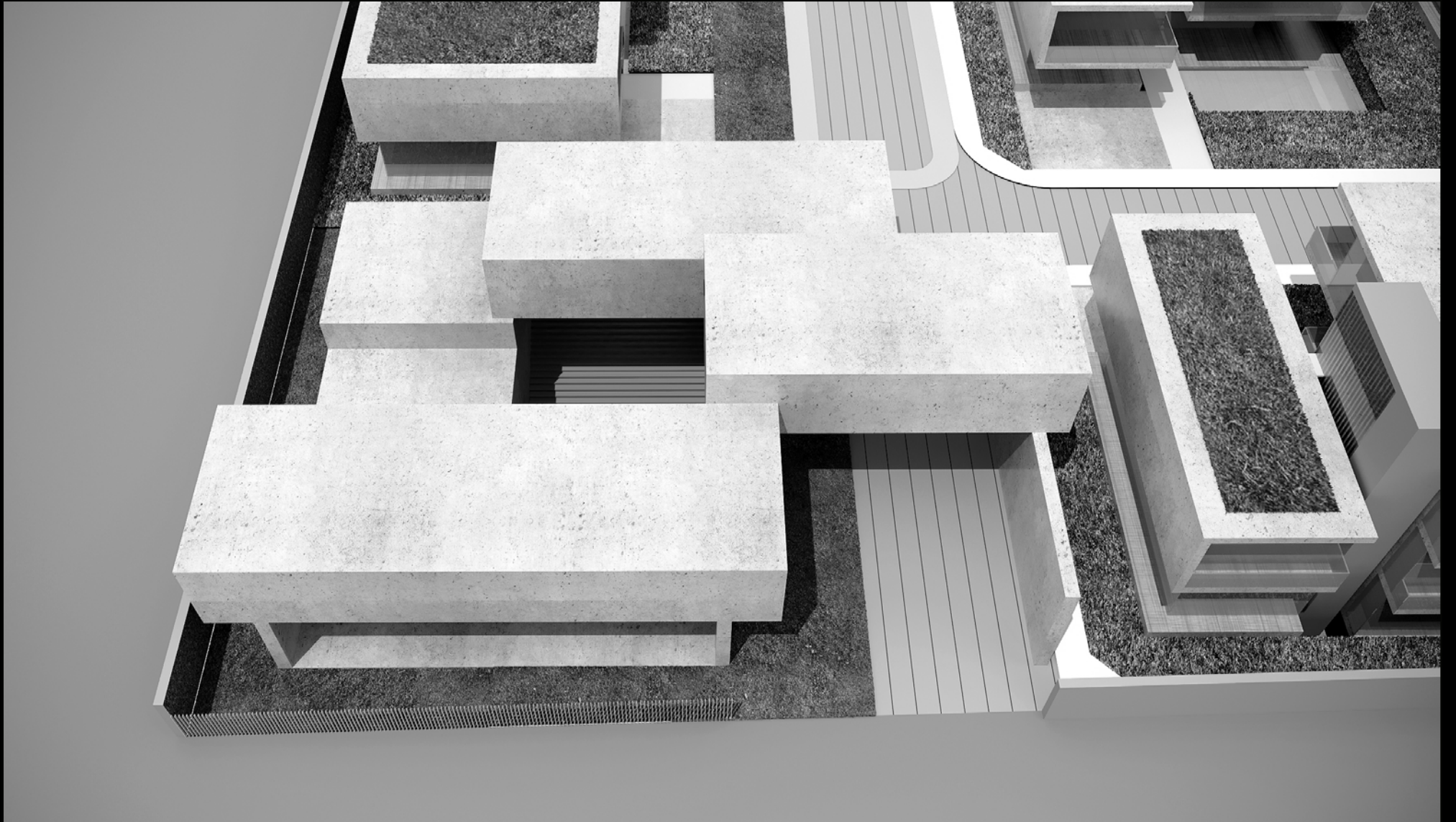

thank you