

# ویلا اردیبهشت



نما

























روف گاردن

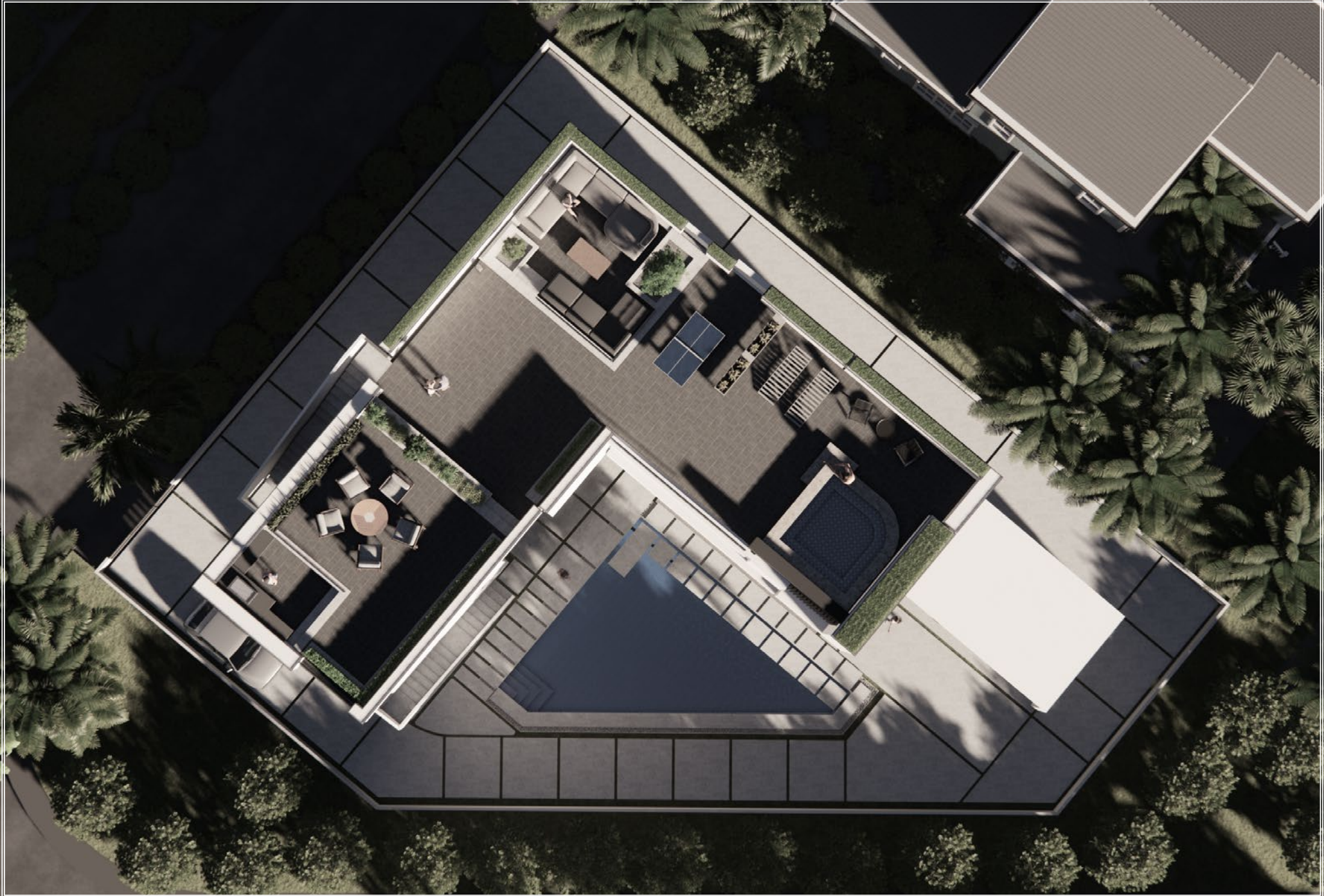





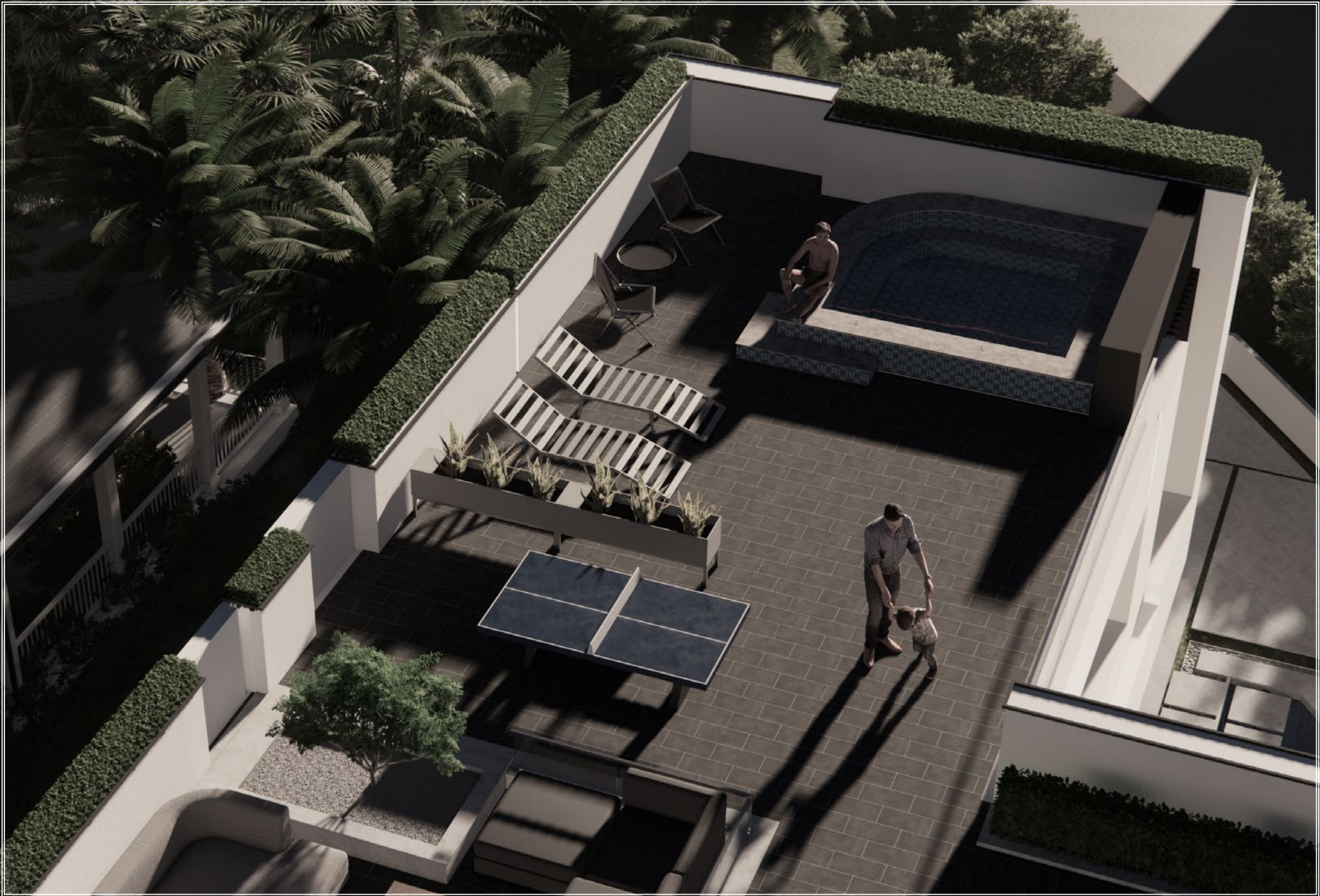





دیاگرام

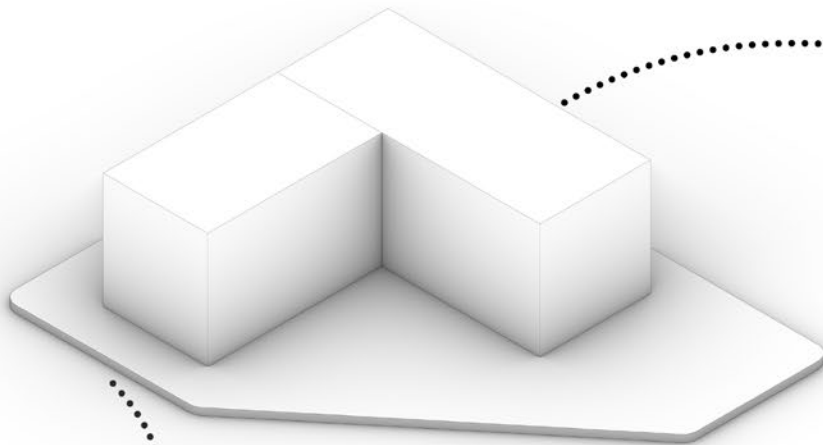

طراحی L شکل و ایجاد فرو  
رفتگی در قسمت اتصال دو  
حجم جهت ایجاد حس  
دعوت کنندگی

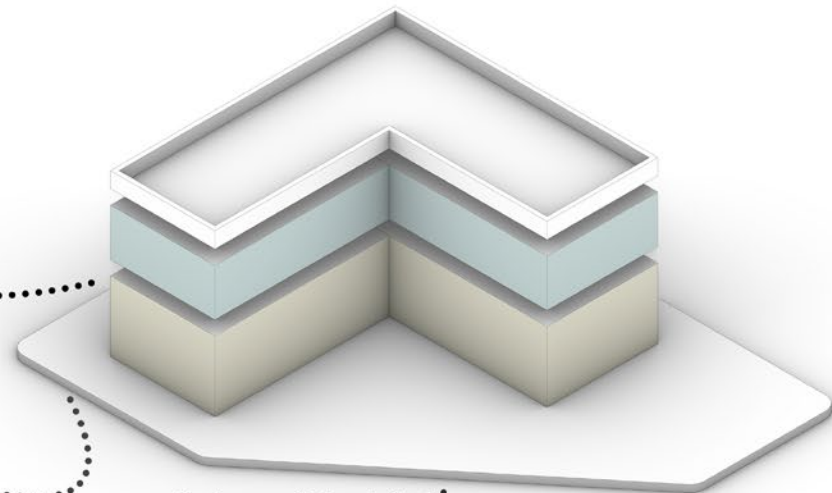

ارتفاع طبقه همکف به  
صورت حداکثری در  
نظر گرفته شده است

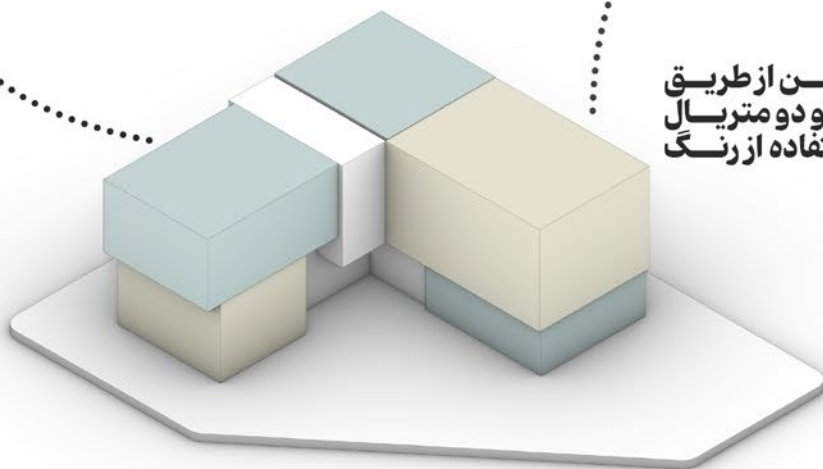

ایجاد سایه روشن از طریق  
ترکیب اجسام و دو متریال  
متفاوت و استفاده از رنگ  
های متضاد

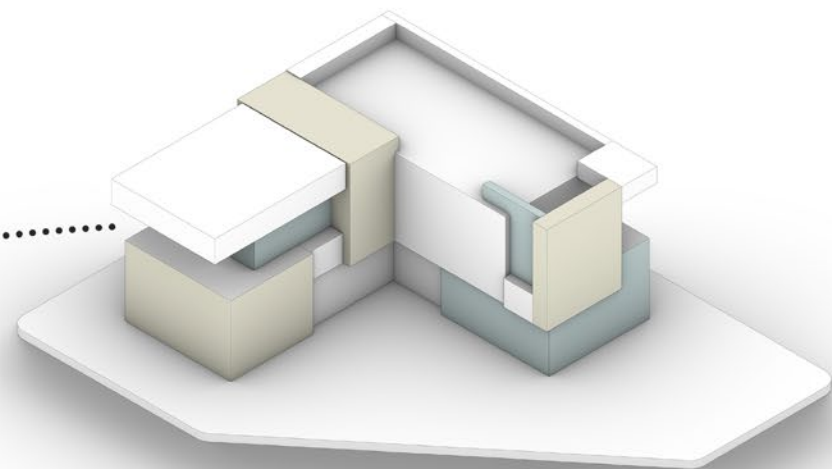

ترکیب عناصر افقی و  
عمودی جهت ایجاد  
سکانس های متنوع  
در نما

ایجاد مسیرهای حرکتی  
سیال و متفاوت با استفاده از  
گف سازی و حرکت بر روی  
آب

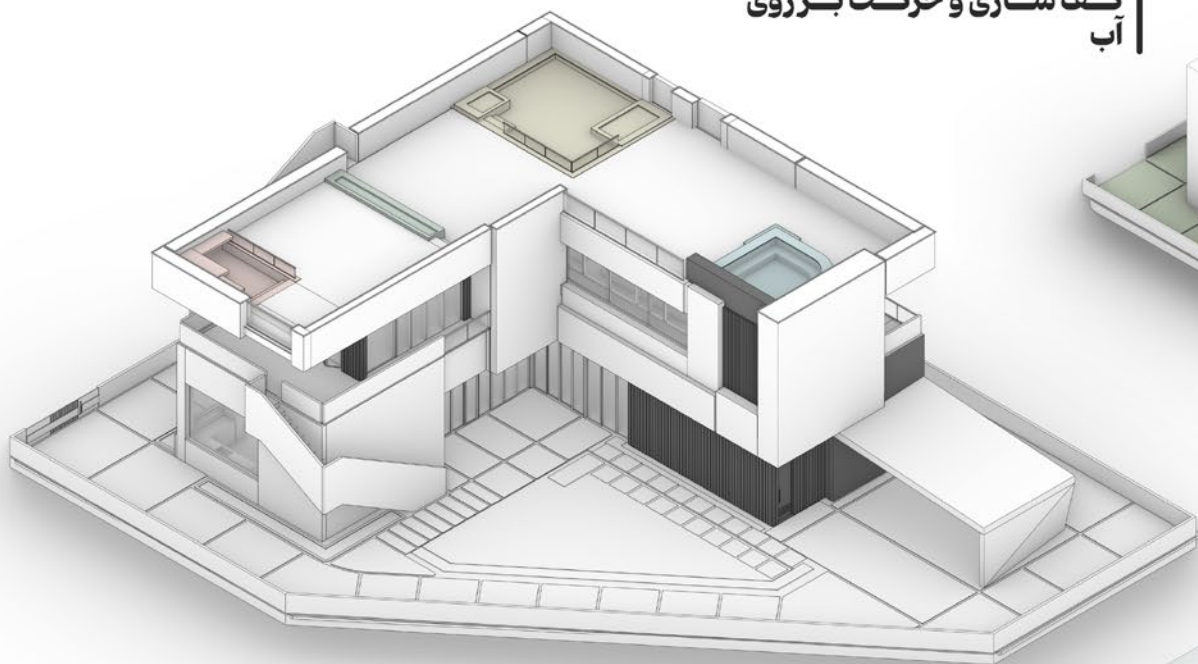
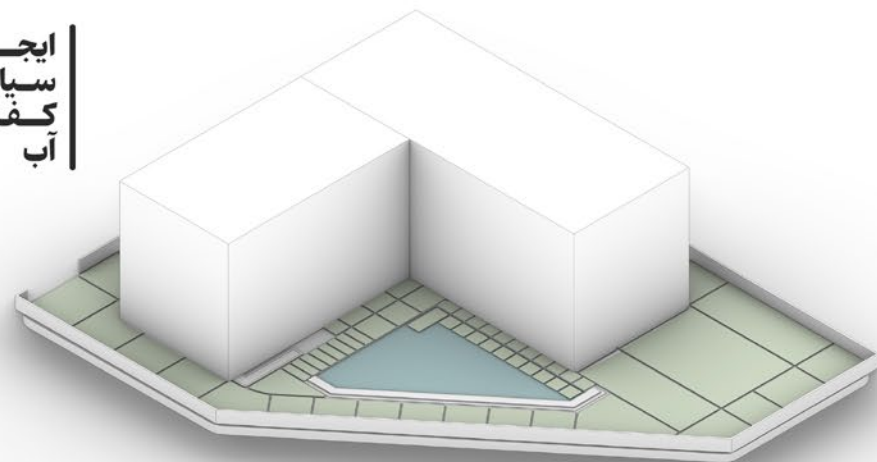

طراحی چکوزی، فضای  
نشیمن، فضای غذاخوری و  
باربیکیو در روف گاردن

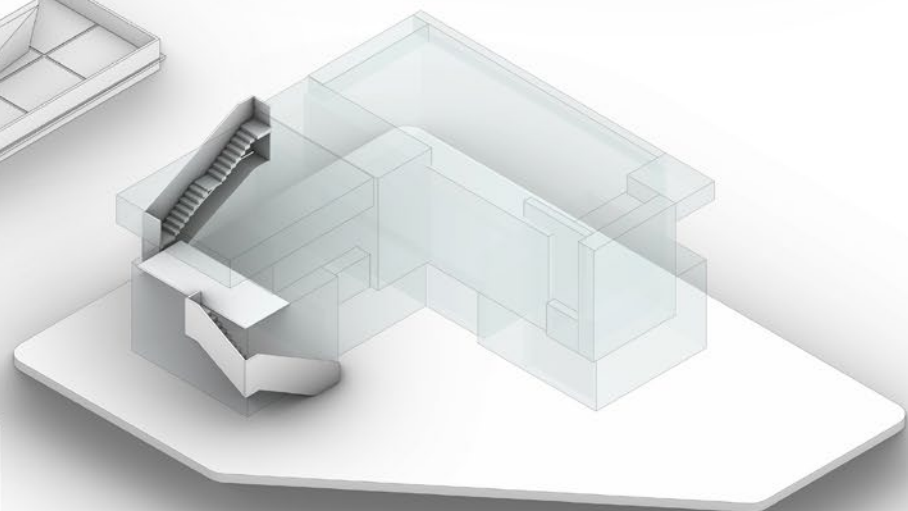

طراحی پلکان در نما و ایجاد  
یک المان مورب جهت  
ایجاد حس حرکت و تنوع  
دید در نمای مجموعه

# site plan

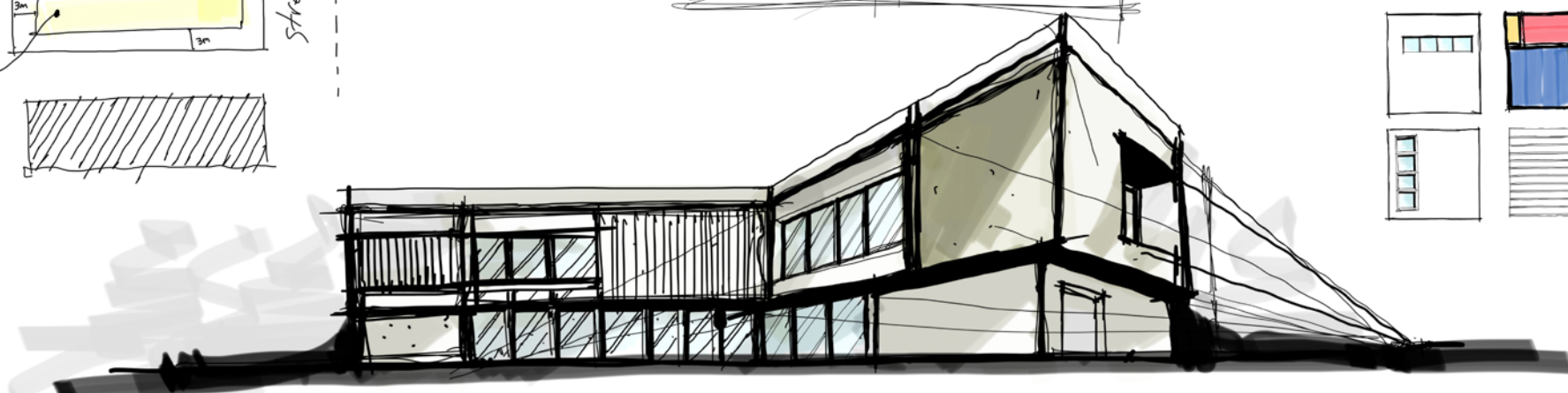
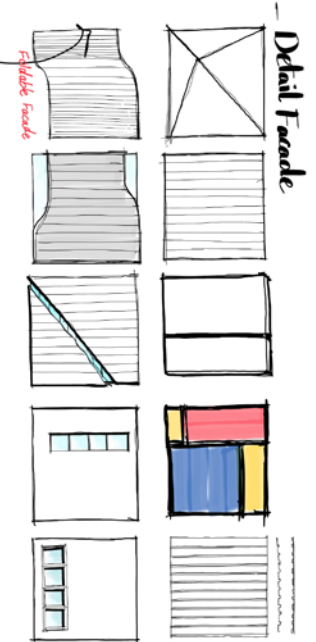
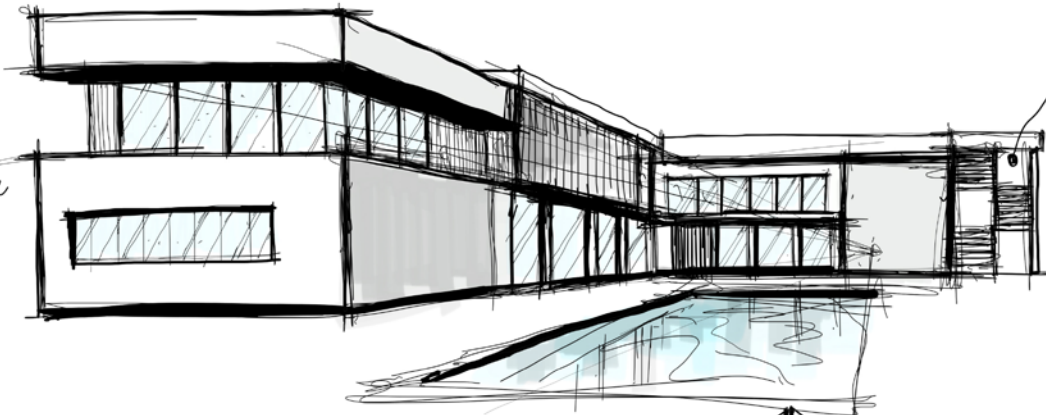
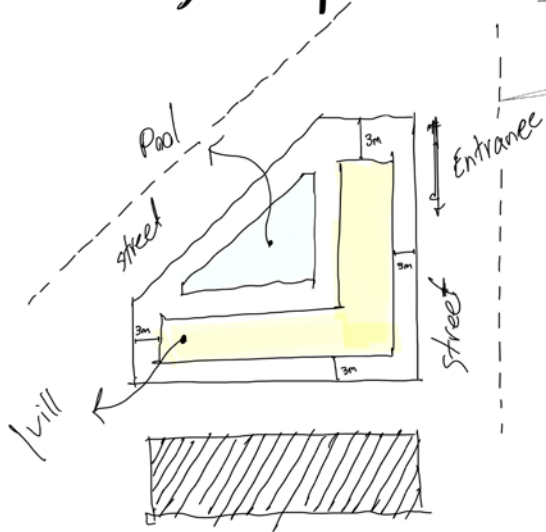

# Spaces Diagram



# Heights

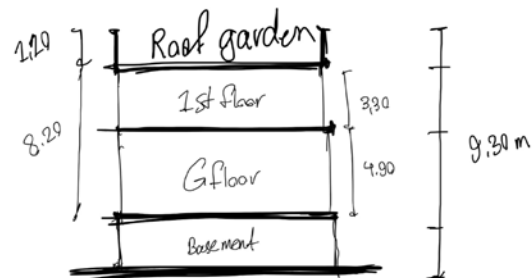

# PLAN



مقطع







پلان

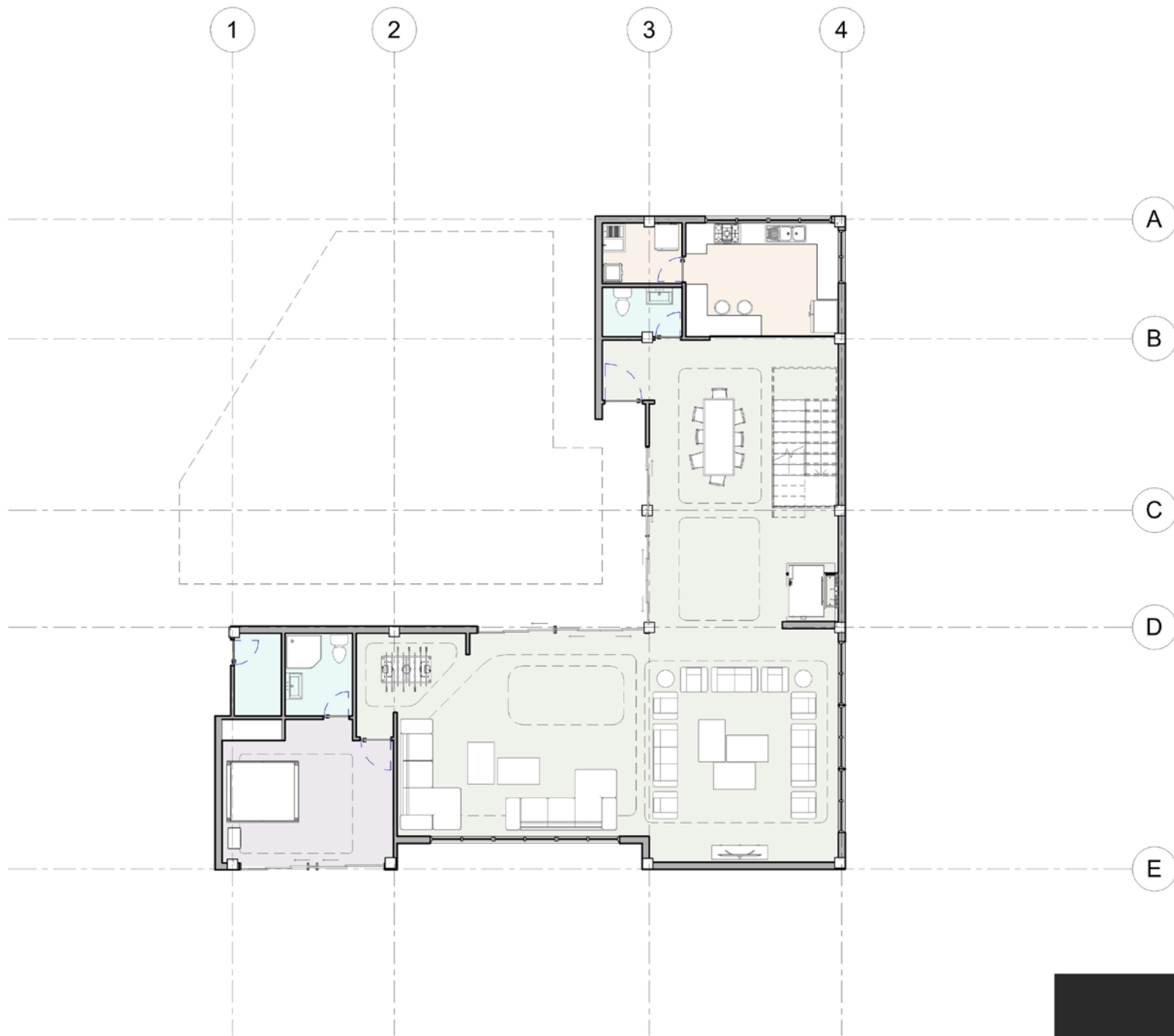

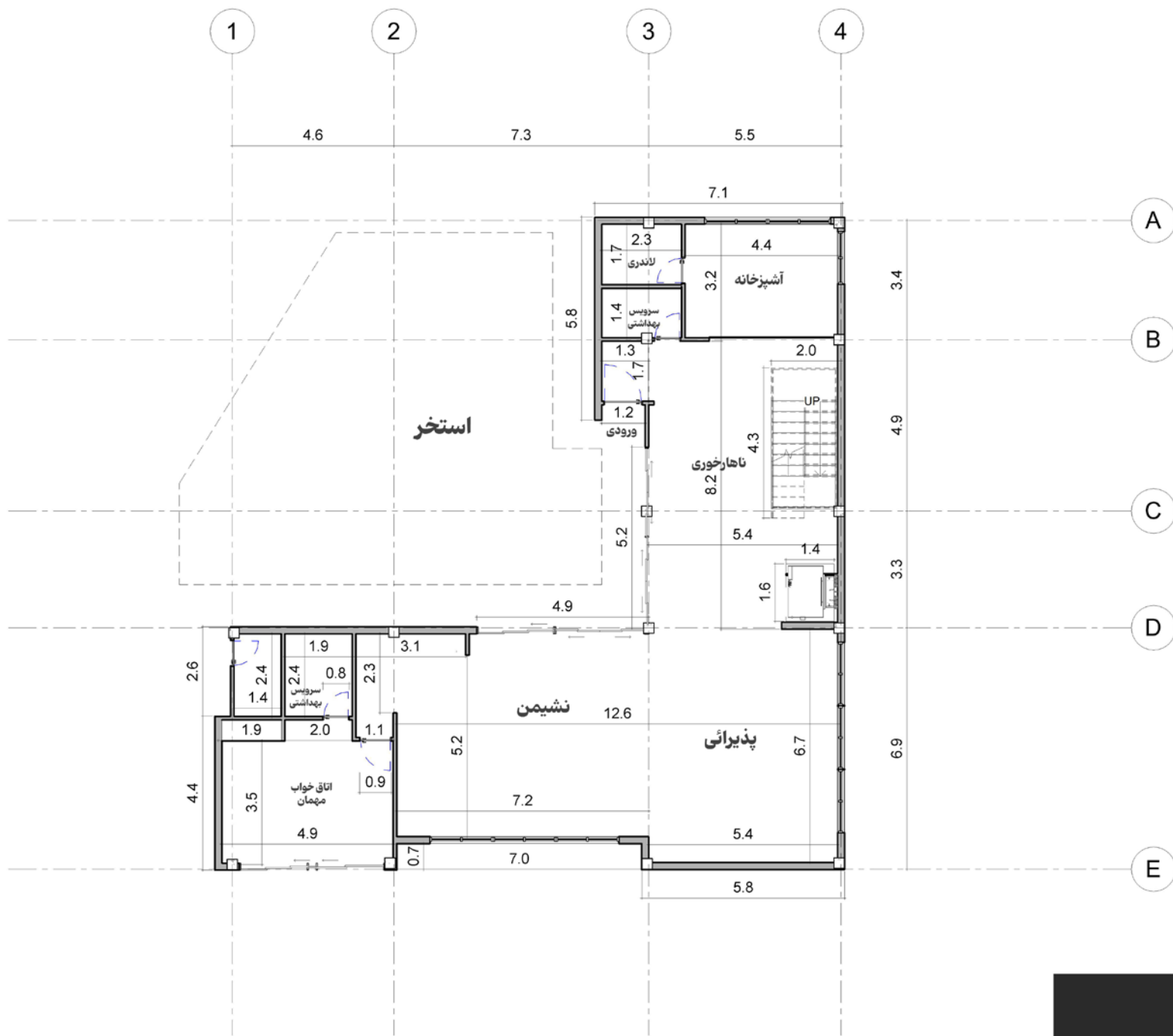



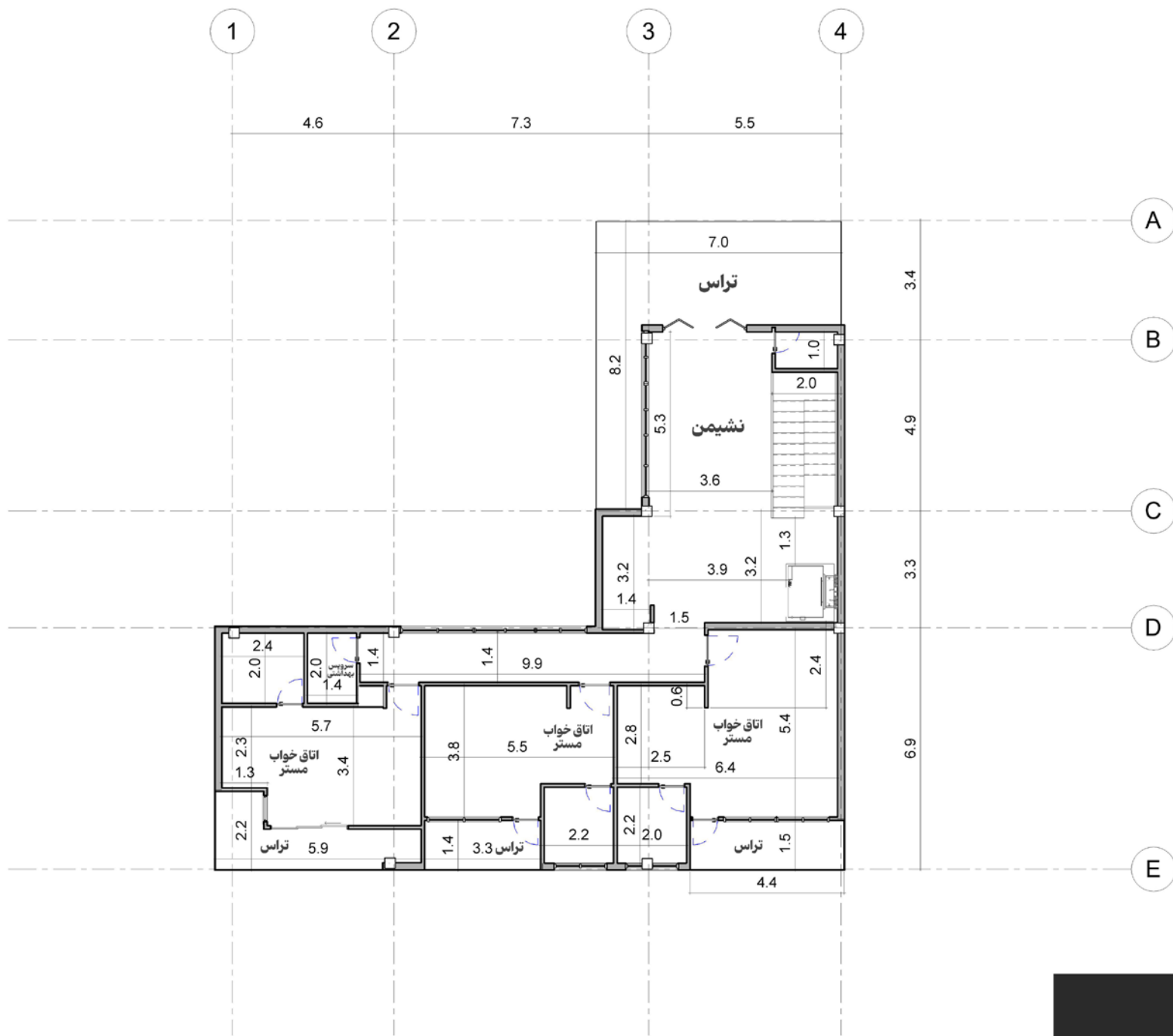

پلان اندازه گذاری  
**طبقه اول**

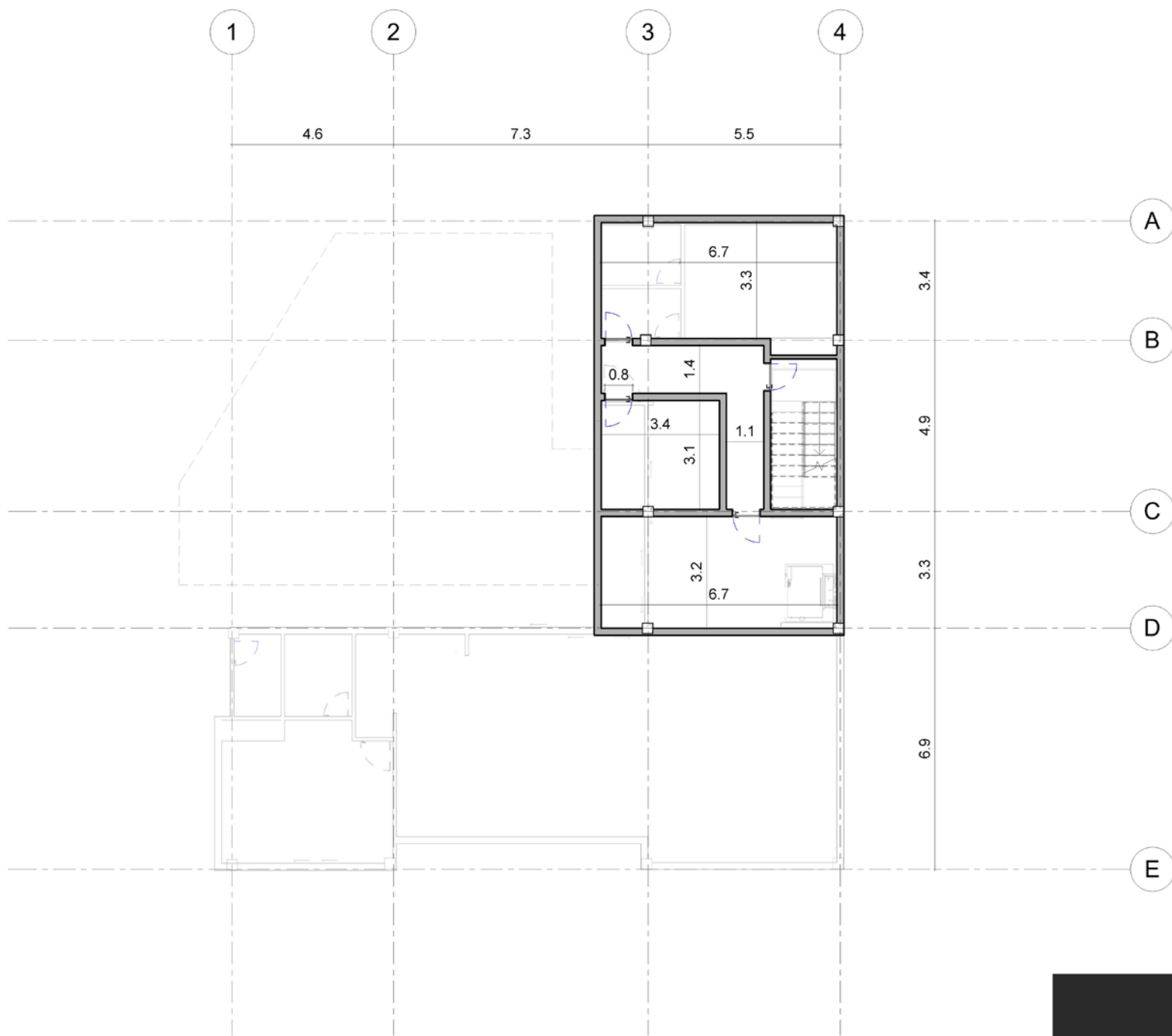



# ویلا اردیبهشت

