

GROUND FLOOR PLAN 

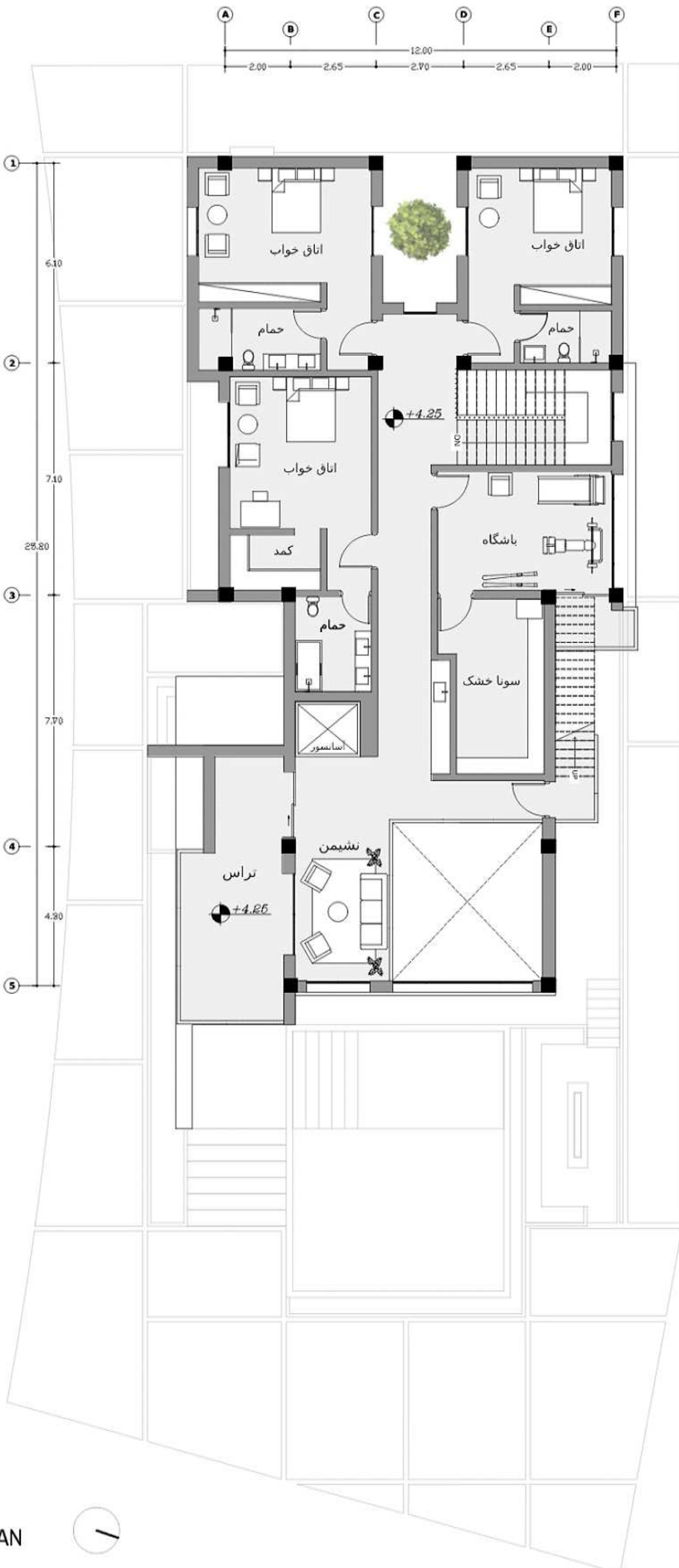

FIRST FLOOR PLAN

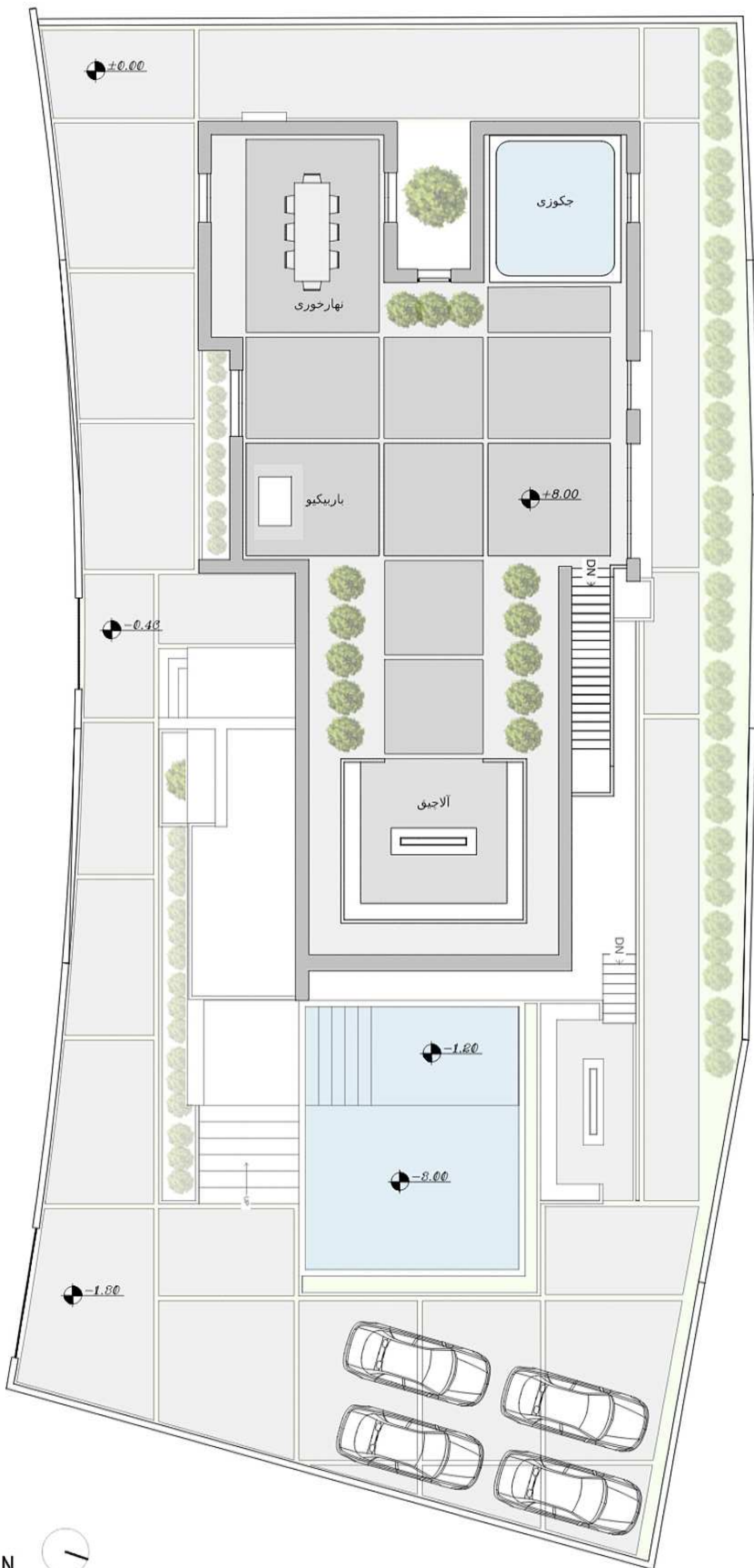



SITE PLAN



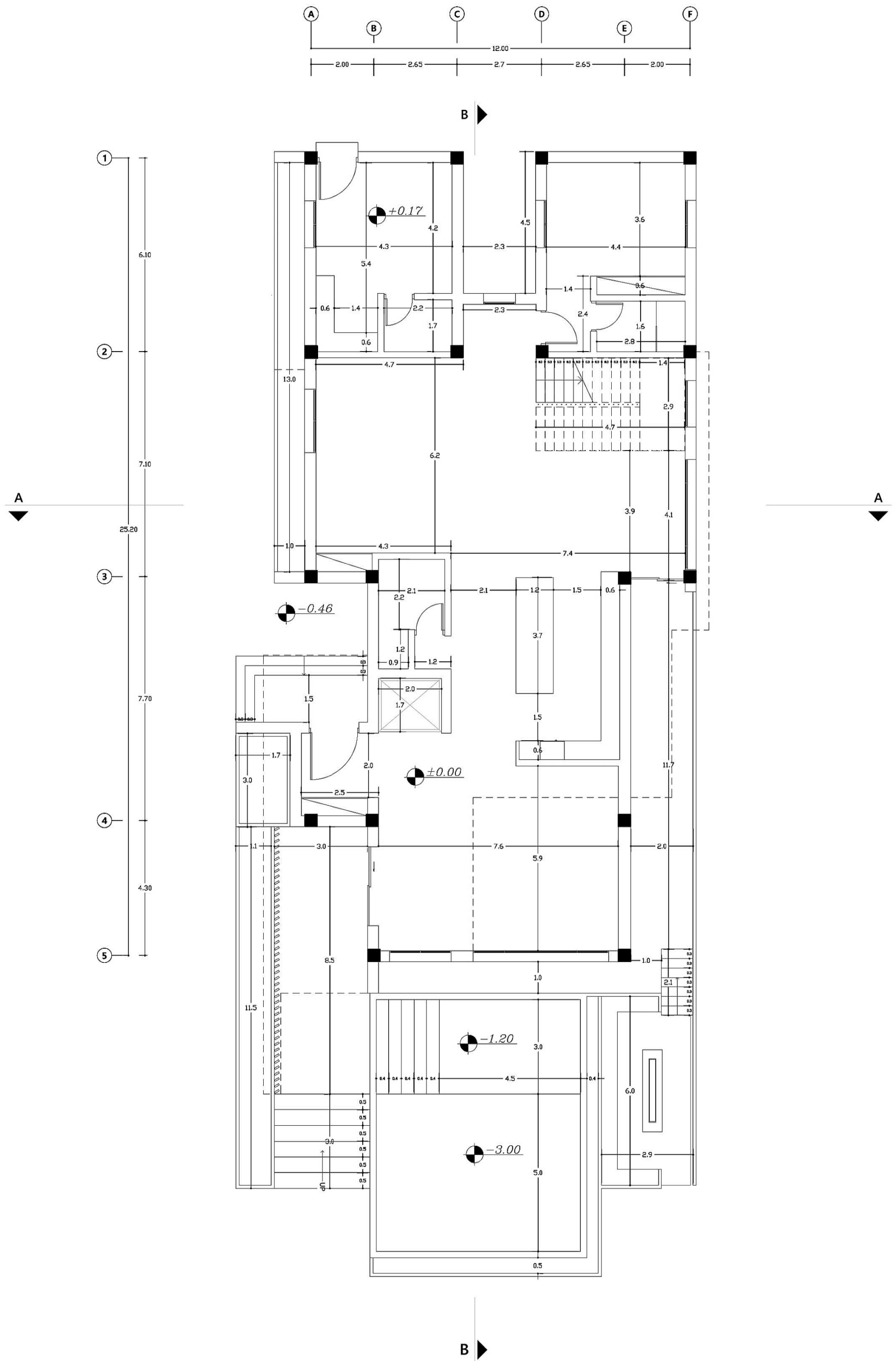

# GROUND FLOOR DIMENTION PLAN

Area: 270 m<sup>2</sup>

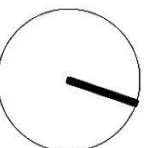

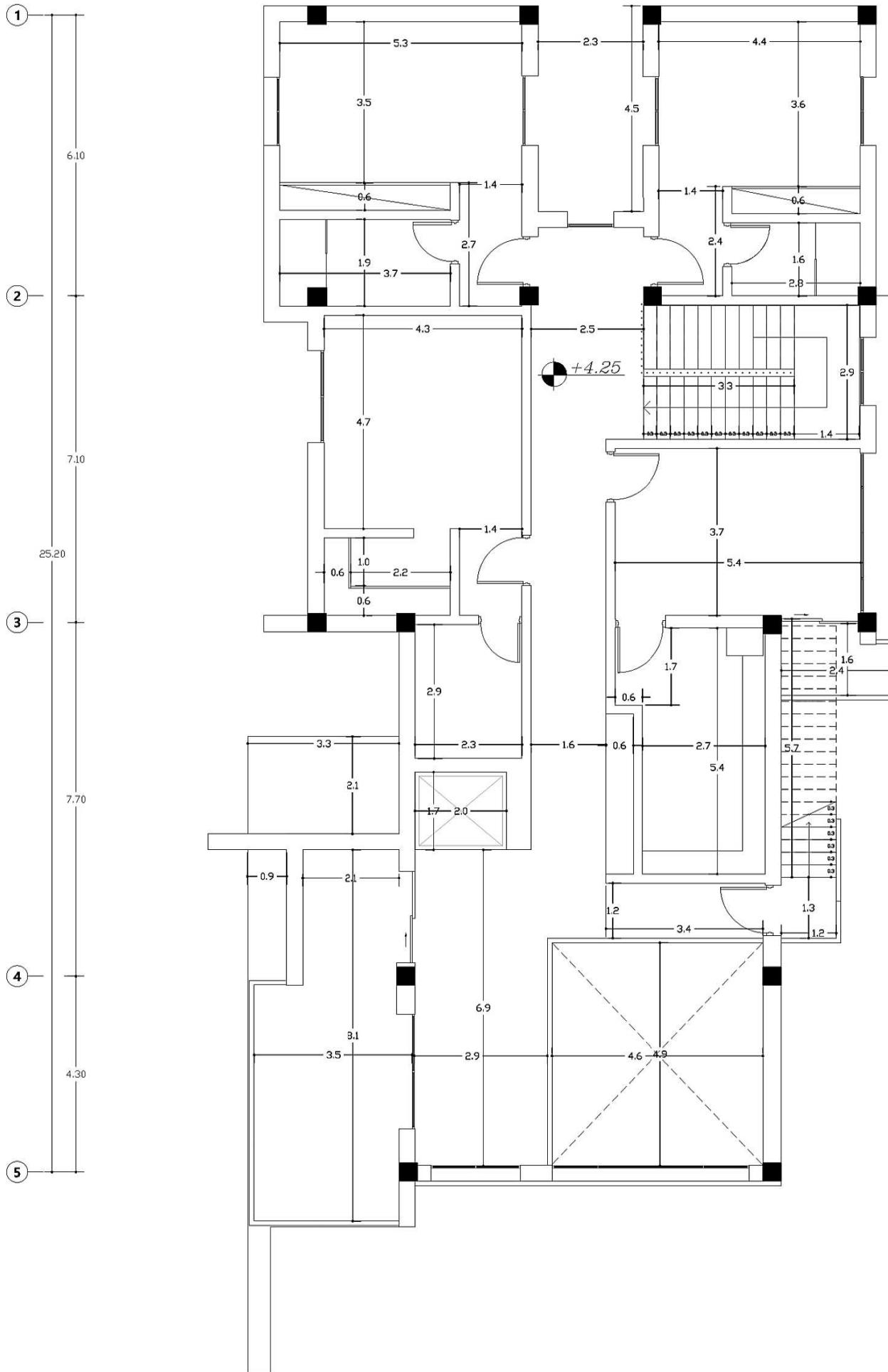
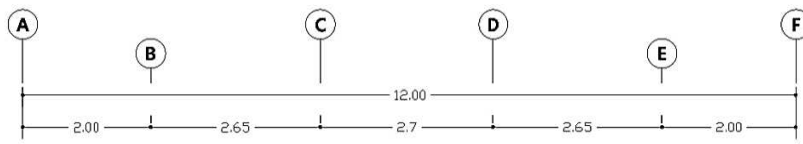

# FIRST FLOOR DIMENTION PLAN

Area: 270 m<sup>2</sup>

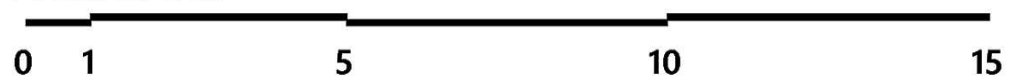

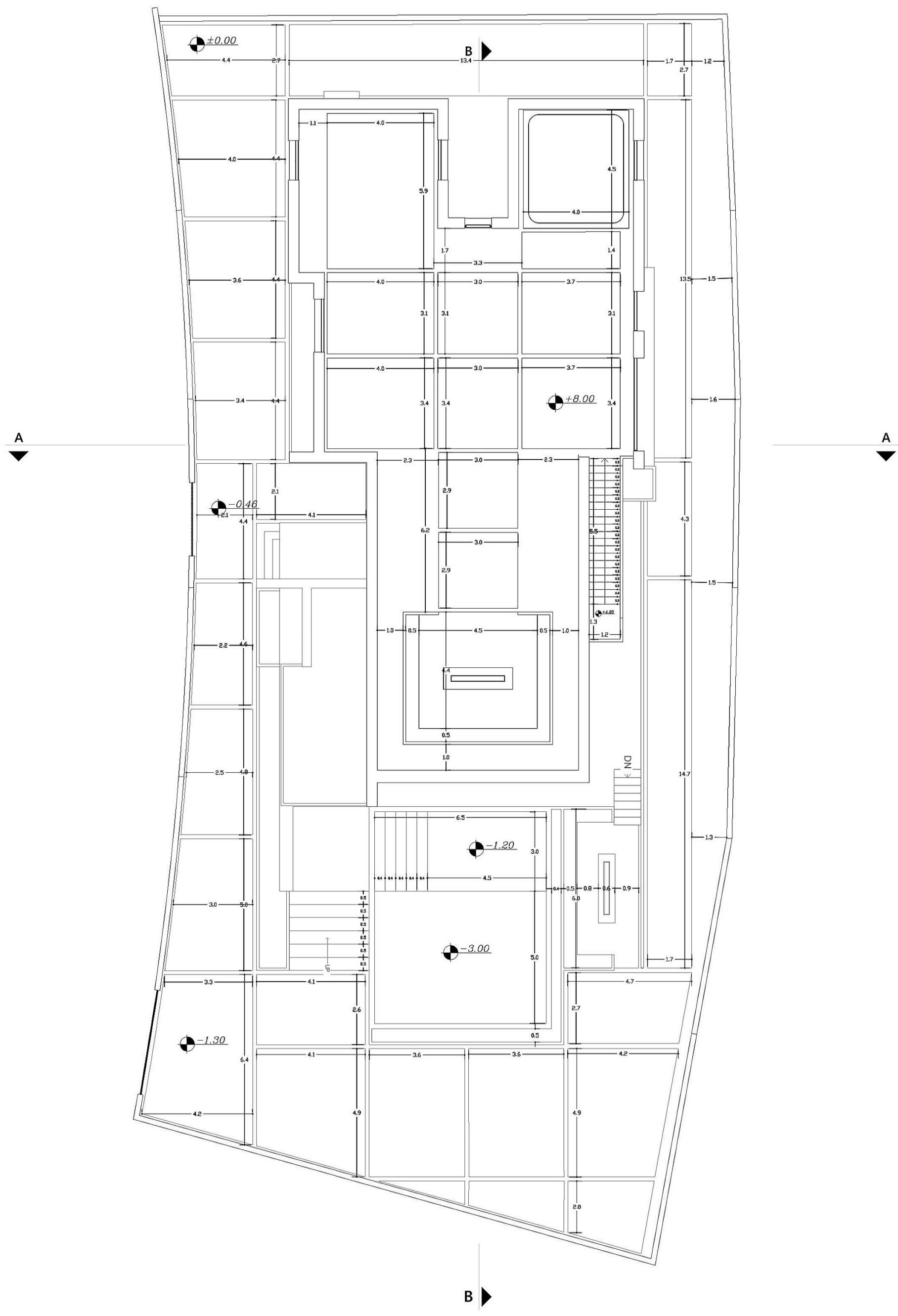

DIMENTION SITE PLAN

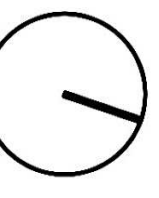

مرحله ۶: فرم نهایی

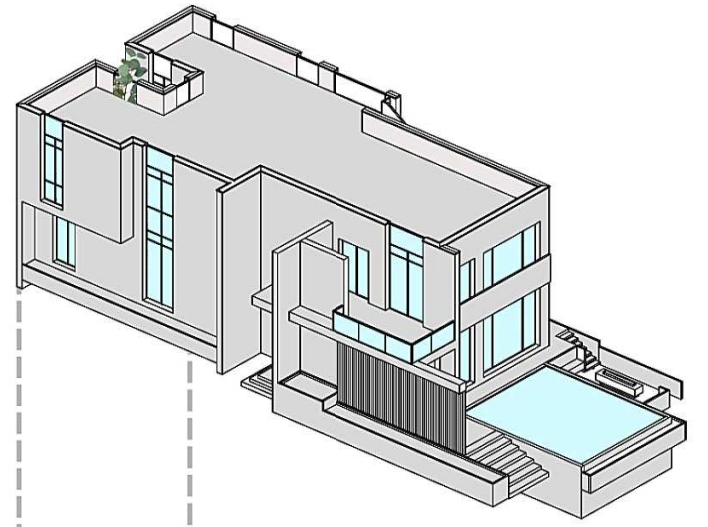

مرحله ۵: اضافه کردن استخر و تراس در طبقه همکف

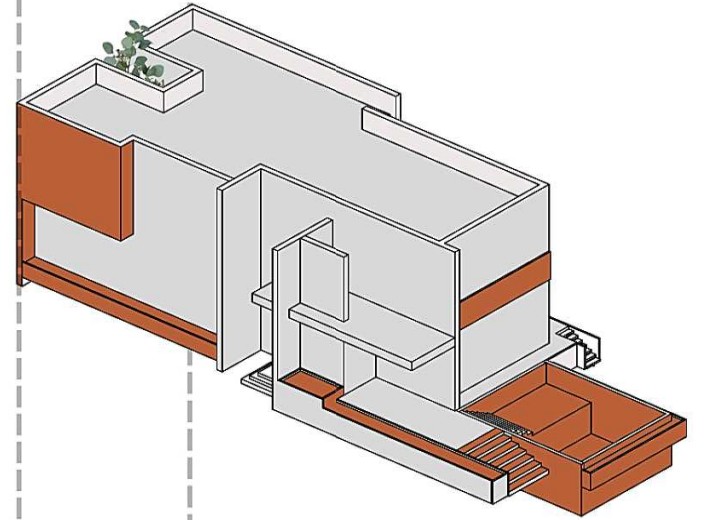

مرحله ۴: ایجاد تراس در طبقه دوم

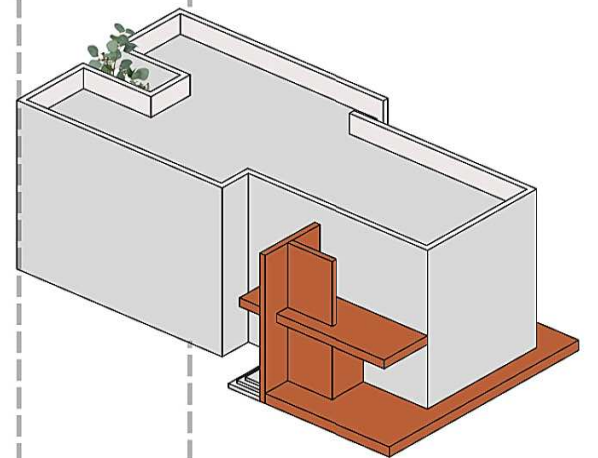

مرحله ۳: ایجاد فرورفتگی در حجم برای حریم بیشتر ورودی و القای حس دعوت کنندگی

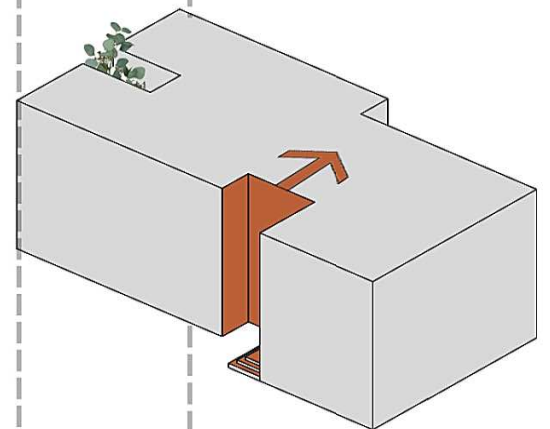

مرحله ۲: ایجاد فرورفتگی و بیرون زدگی در حجم برای نورگیری بیشتر

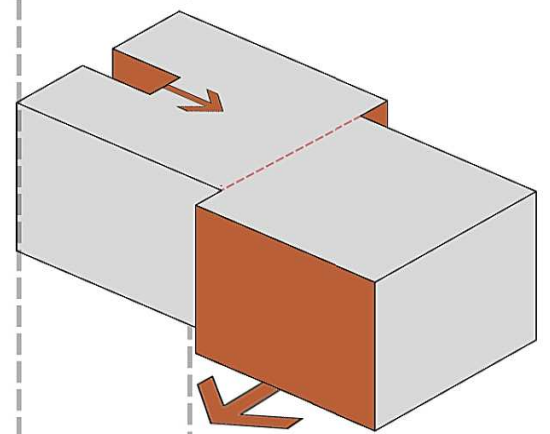

مرحله ۱: مستطیل شرقی-غربی برای بیشترین نورگیری

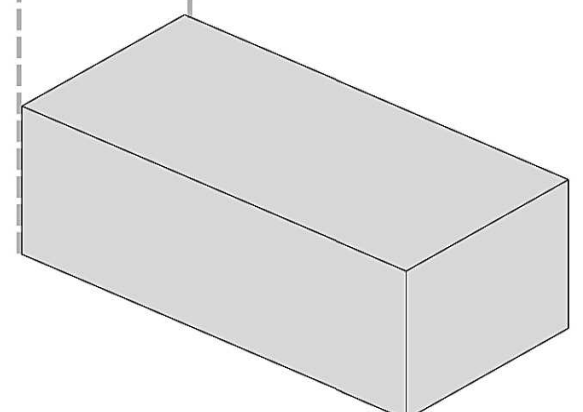

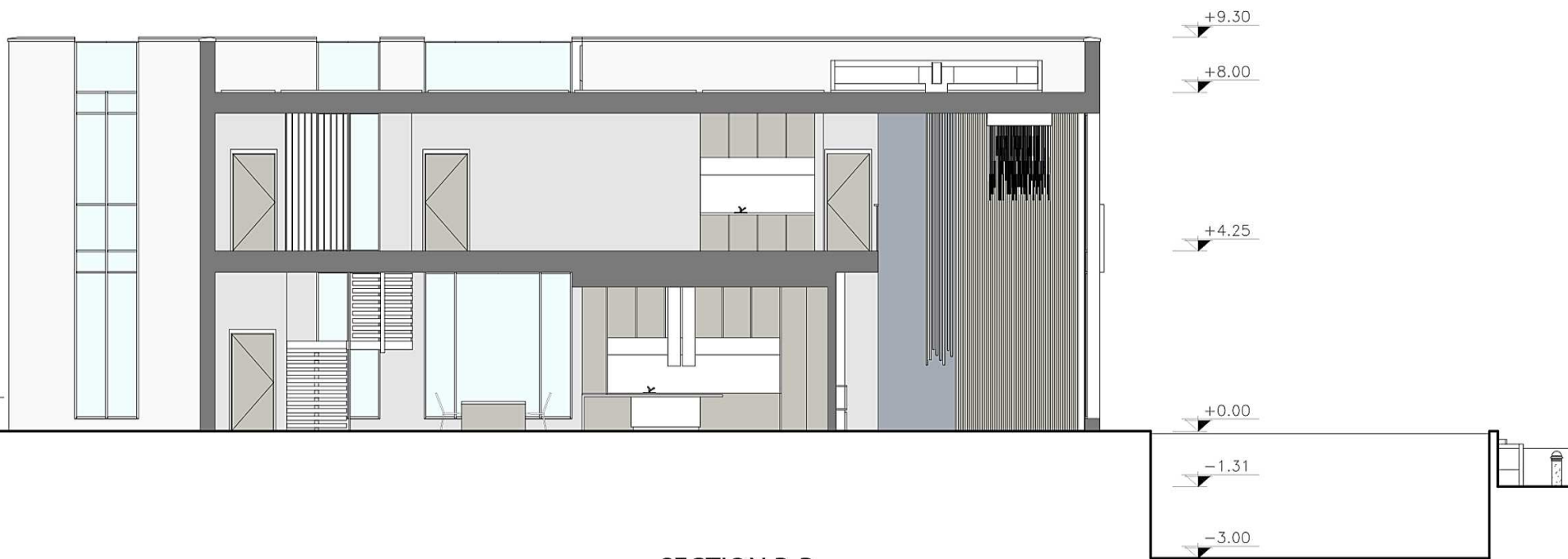

SECTION B-B



SECTION A-A

















