

Brick Jacket

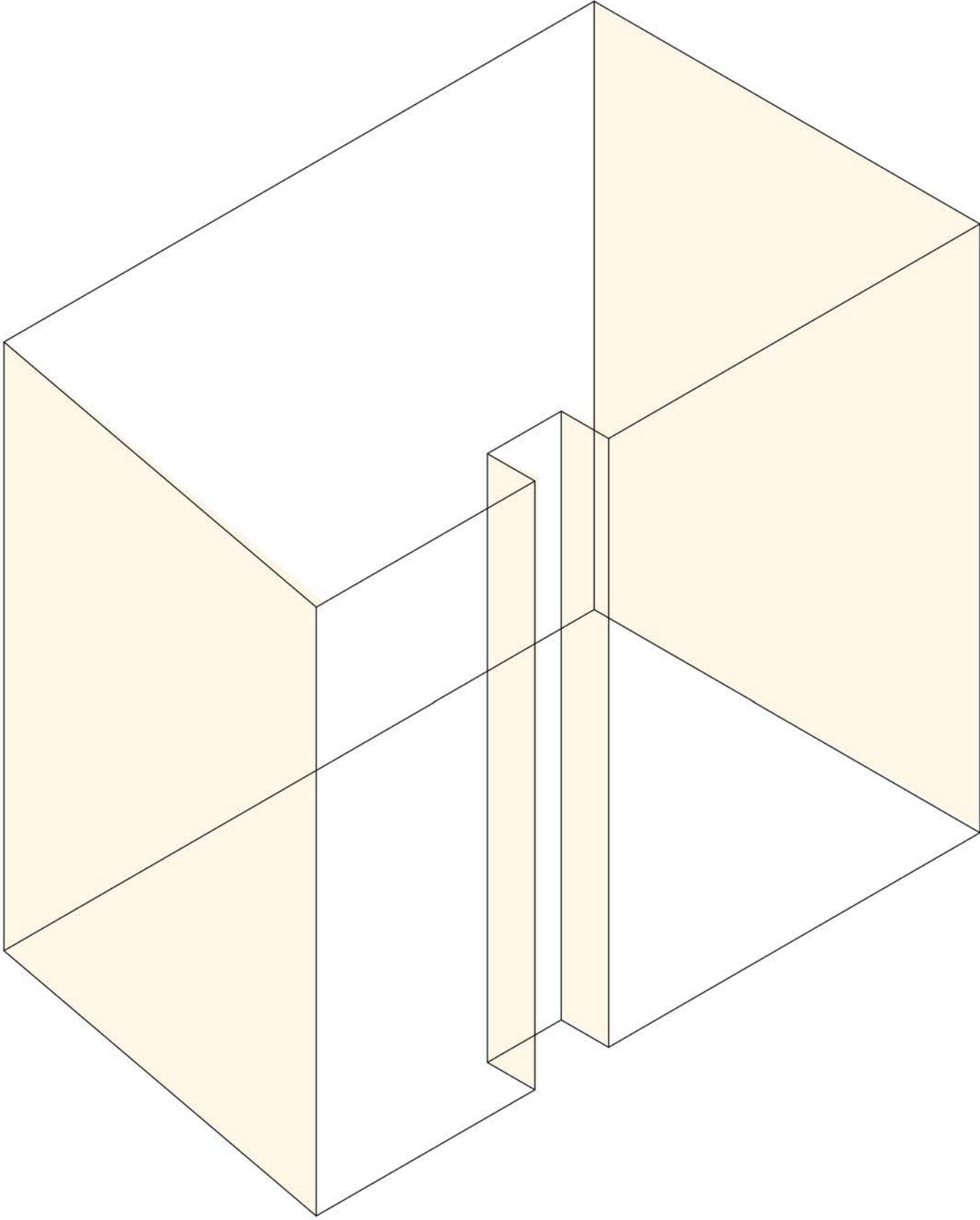

Day Light

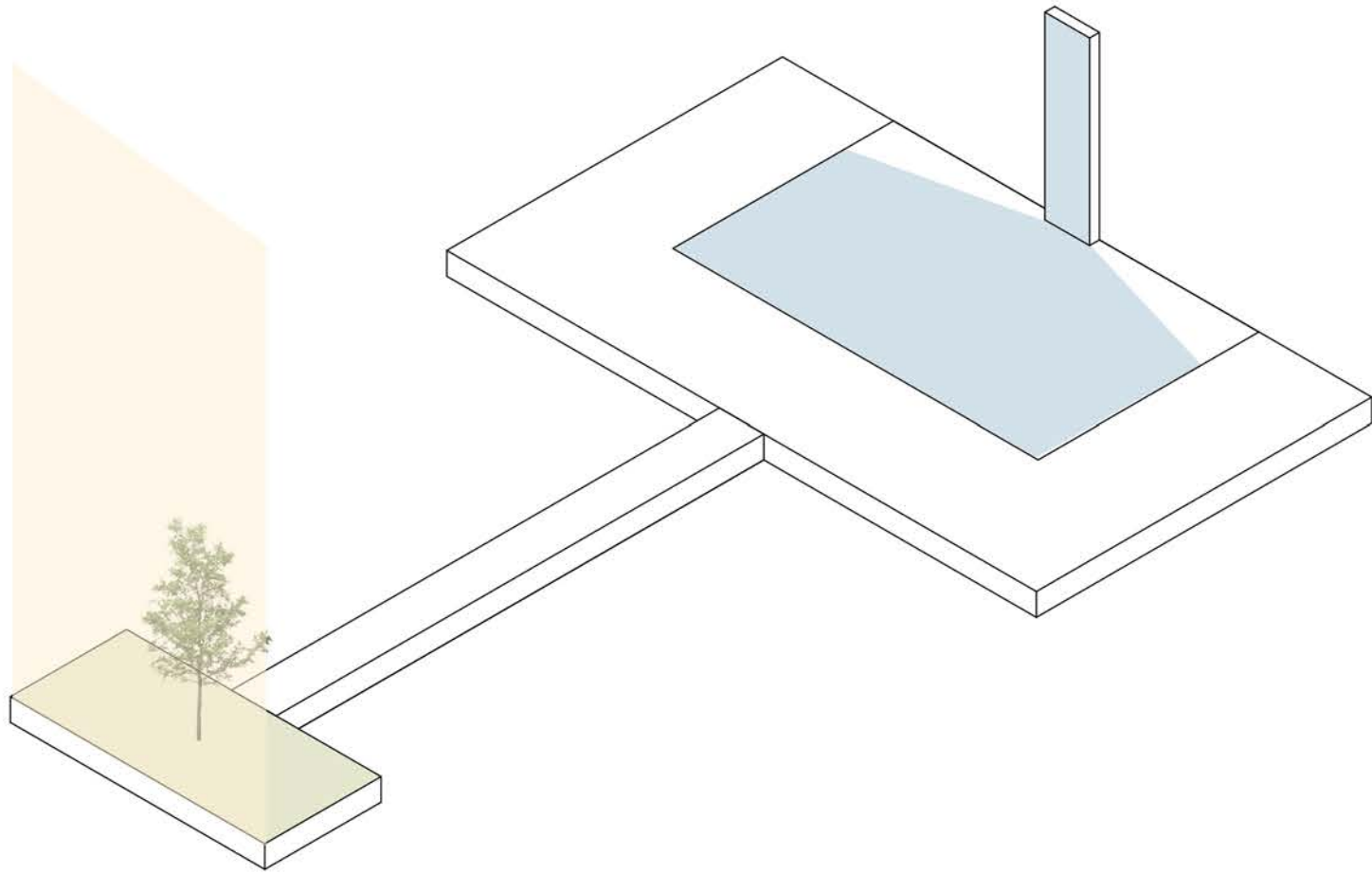

Underground -3

- متریال اصلی نما آجر روشن بوده که در غالب چند غلاف پوشاننده ظاهر شده است. شیشه، ورق های مشکی و ترمووود در طبقات مختلف و فضایی غیر از این پوسته ها به نمایش گذاشته شده است.
- در طراحی پلان واحدها همه ی اتاق ها دارای سرویس و حمام مجزا هستند. نورگیری فضاها حداکثری است و تلاش بر این بوده که از جداره های موجود حداکثر بهره برده شود. همچنین نورگیری یکی از اتاق خواب های واحد بزرگتر از نورگیر مجاور حیاط همسایه تامین شده است
- در طبقه زیر زمین منفی سه کریدور میانی که دسترسی به فضاهای مختلف را تامین میکند، از یک سو به آبشار و آبنمای استخر و از سوی دیگر به گود نور و فضای سبز موجود در آن دید دارد و احساس حضور در طبقه زیرزمین را تلطیف می نماید.
- در طبقه منفی یک اتاق بازی و در طبقه منفی دو انبارها قرار گرفته است. همچنین باشگاه ورزشی، فضاهای آبی، سینما، سویت سرایدار و تاسیسات در زیرزمین منفی سه واقع شده است.
- حیاط دارای یک مسیر ورودی پیاده از سمت جنوب، رمپ زیرزمین، نشیمن و فایرپیت و همچنین فضای نسبتا باز چند منظوره برای بازی و... نیز در نظر گرفته شده است.
- در طبقه نهایی در اتاق واحد شمالی و پذیرایی واحد جنوبی اسکای لایت در نظر گرفته شده است
- به منظور پویایی نما و تنوع واحد ها، تراس ها در طبقات مختلف جاهایی متفاوتی دارد. همچنین واحد شمالی طبقه سوم و واحد جنوبی طبقه پنجم تراس های بزرگ تری دارند



Ground Floor
Plan

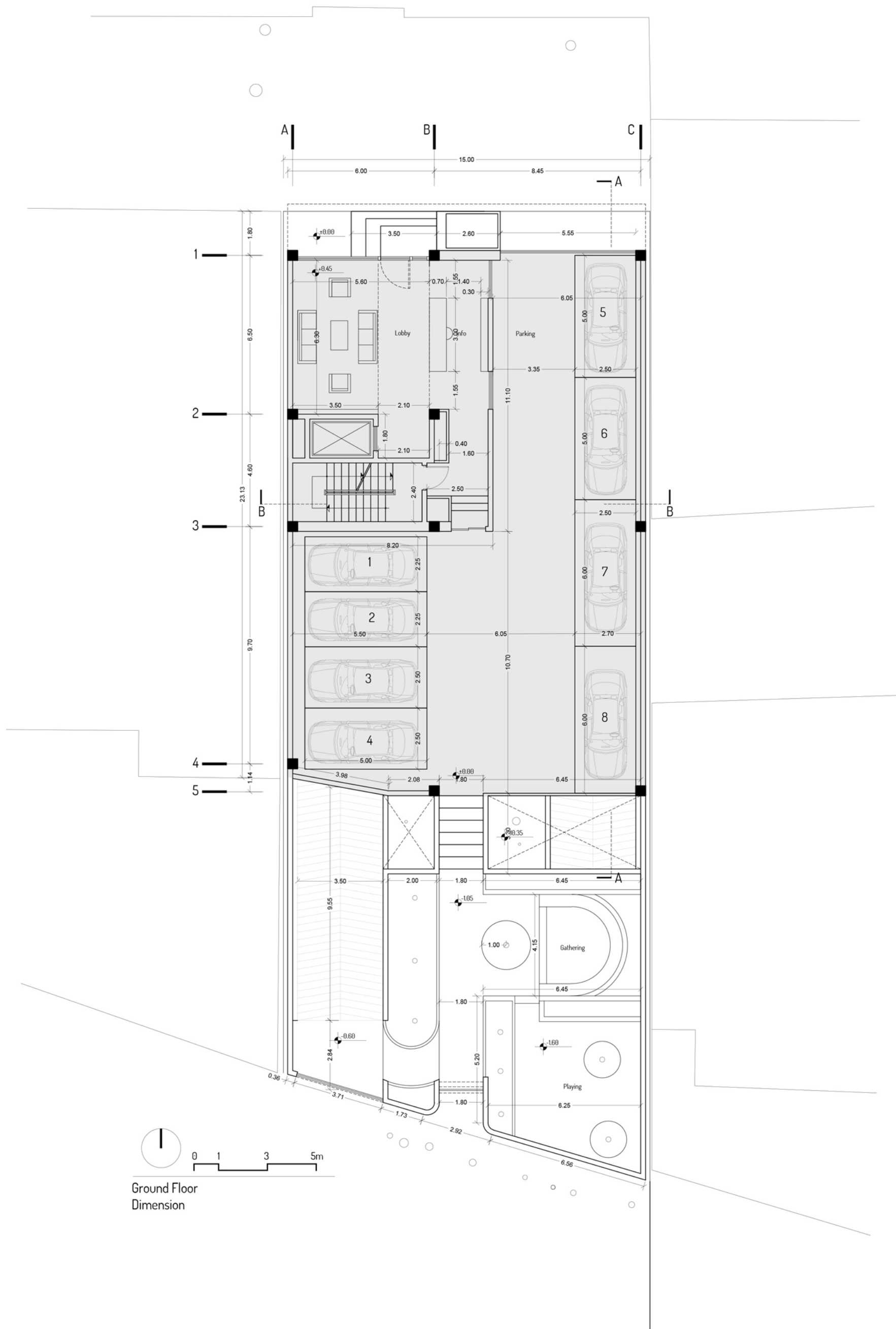

Ground Floor
 Dimension

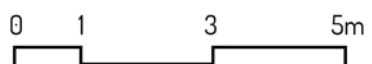
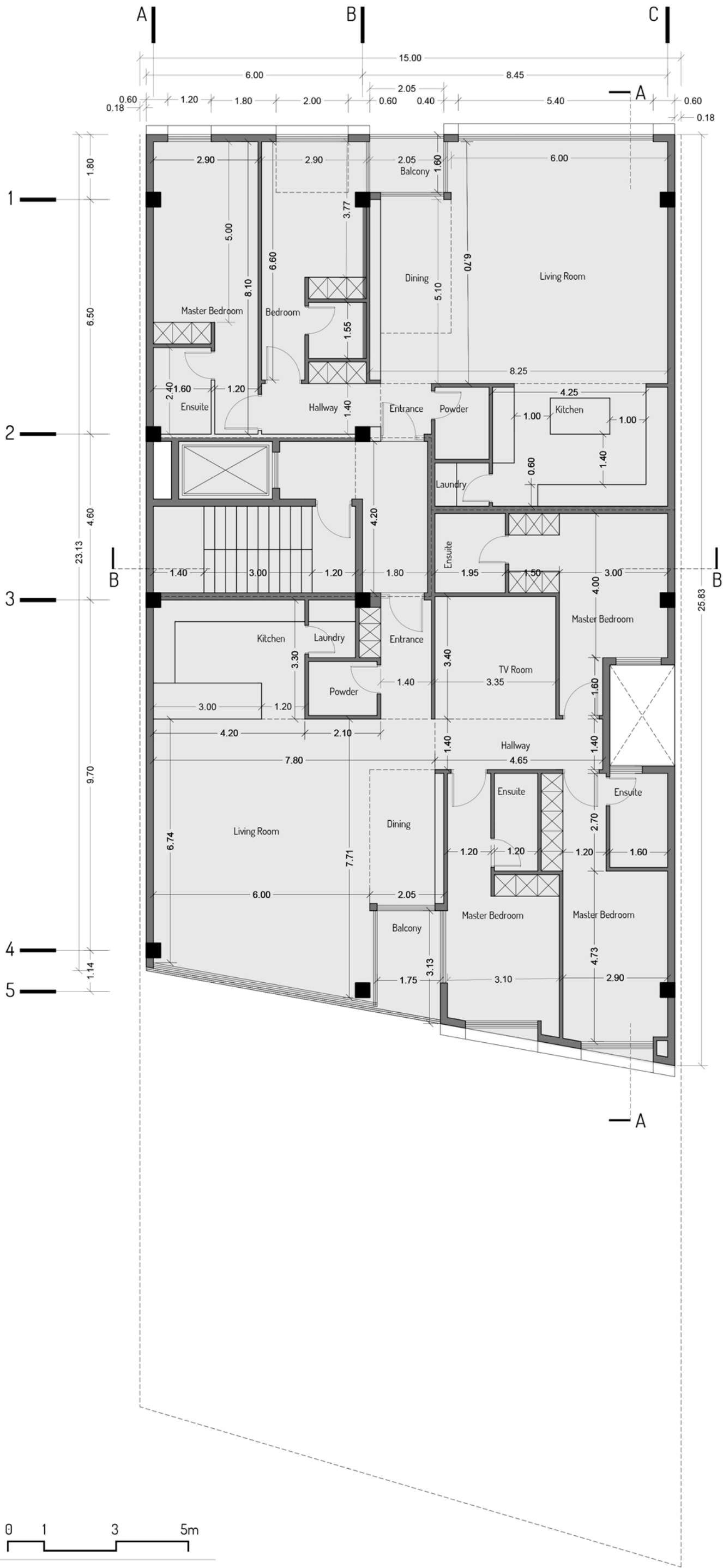

Floor Plan 1
Dimension

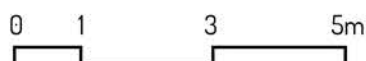
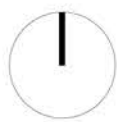

Floor Plan 1

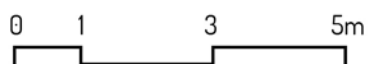
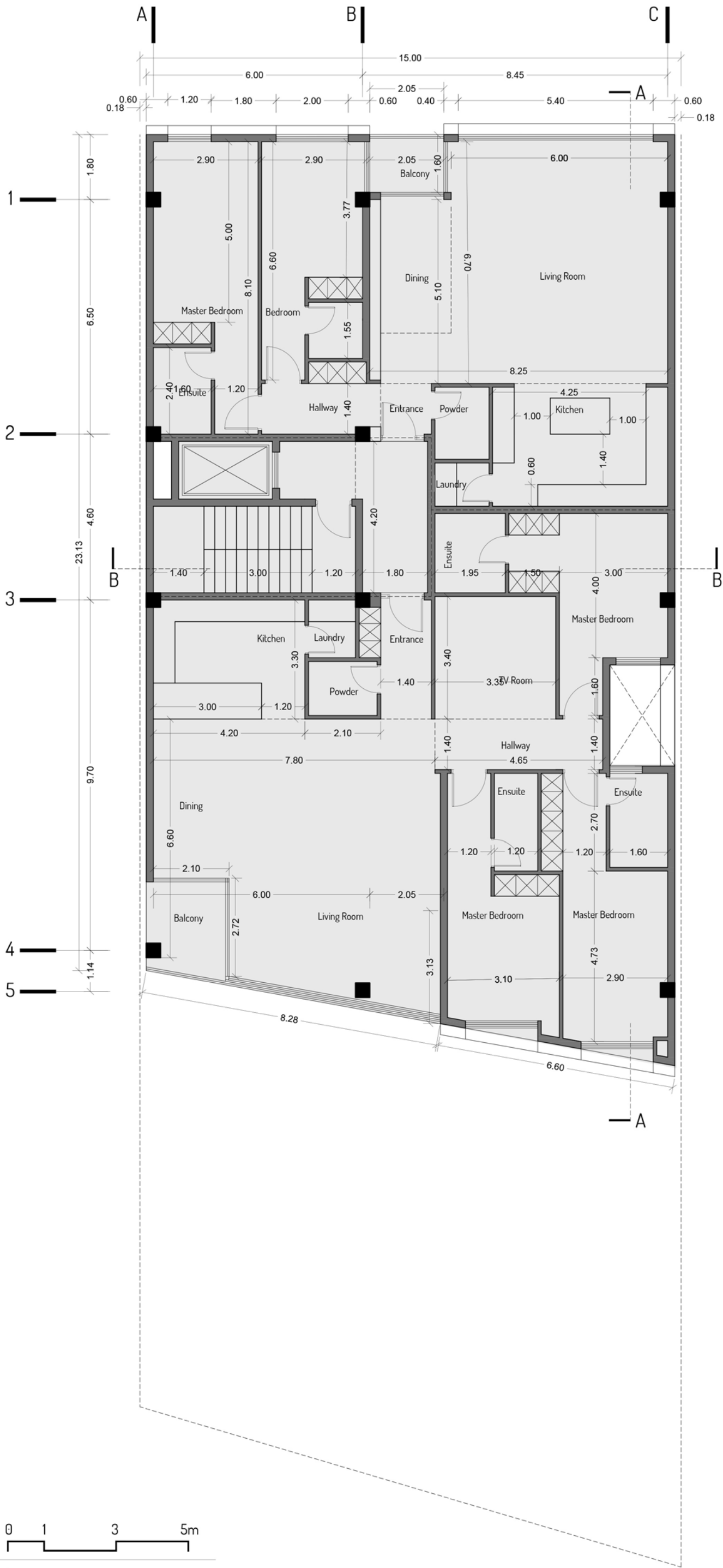

Floor Plan 2 & 4
Dimension

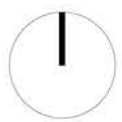

Floor Plan 2 & 4

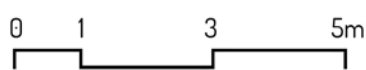
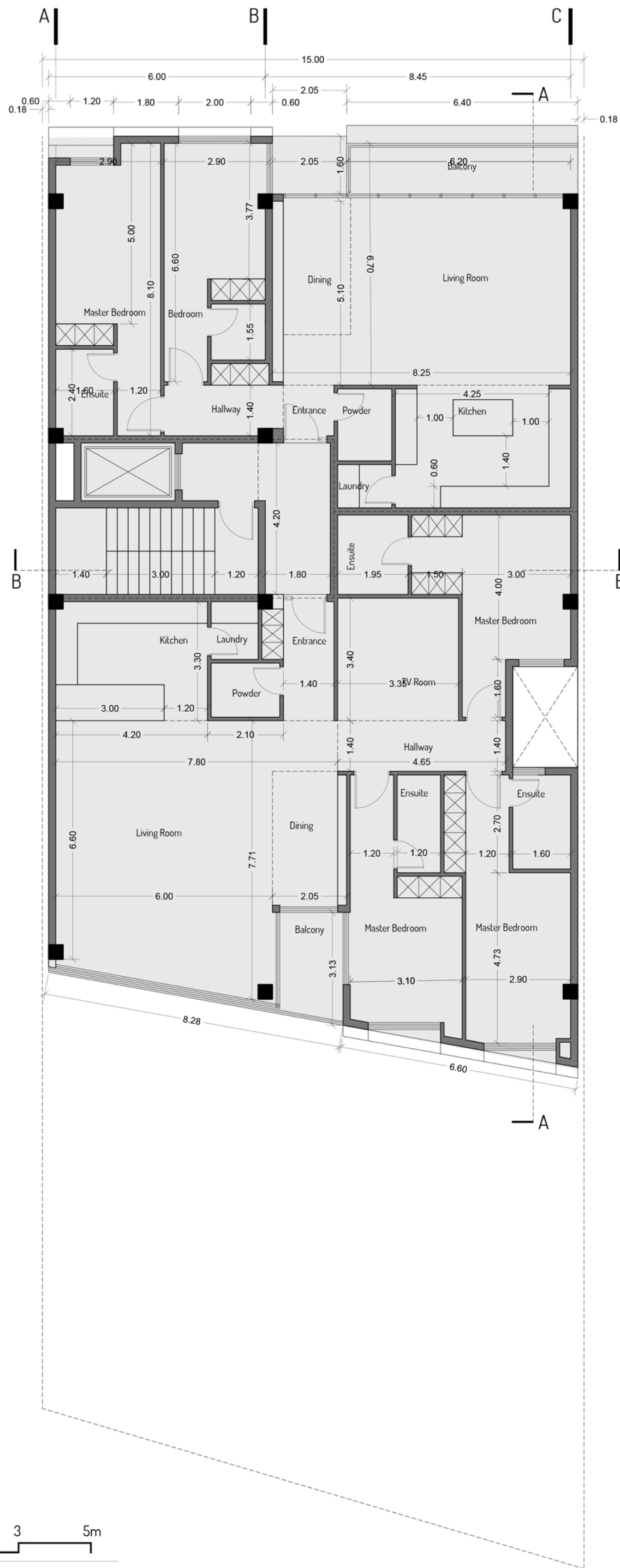

Floor Plan 3
Dimension

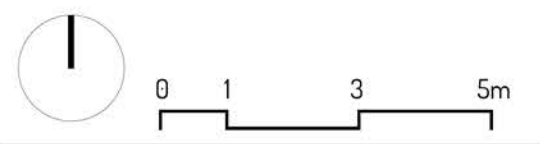
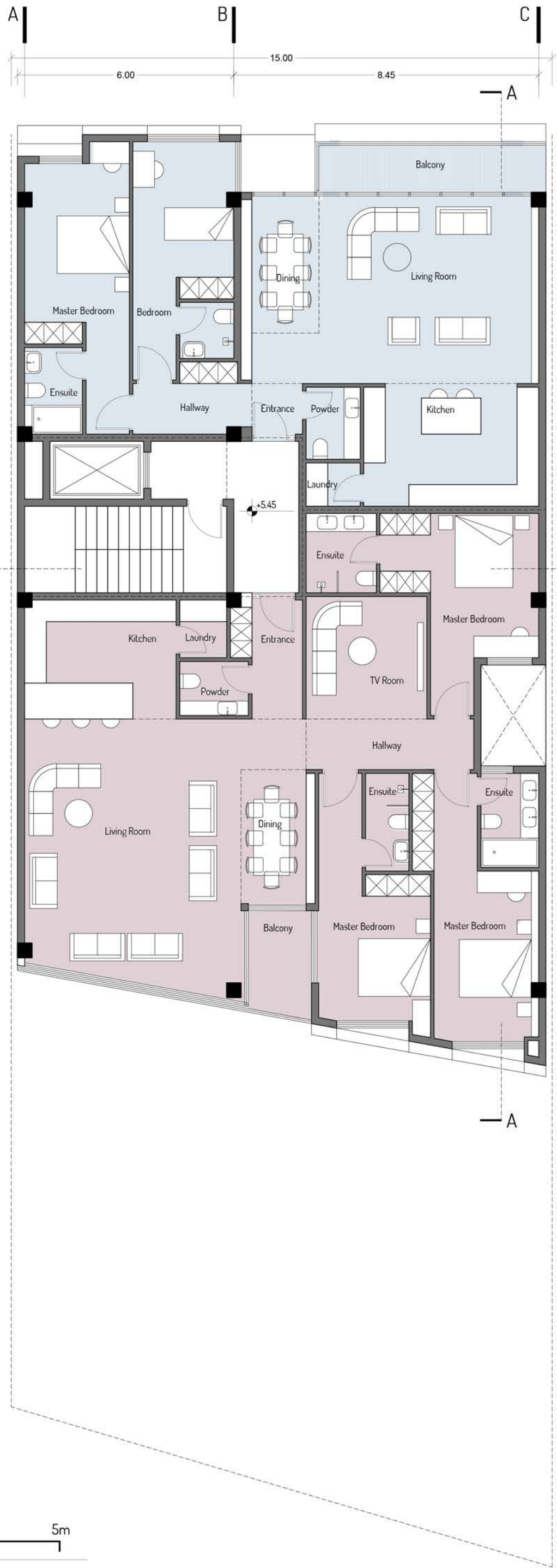

Floor Plan 3

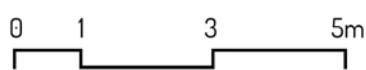
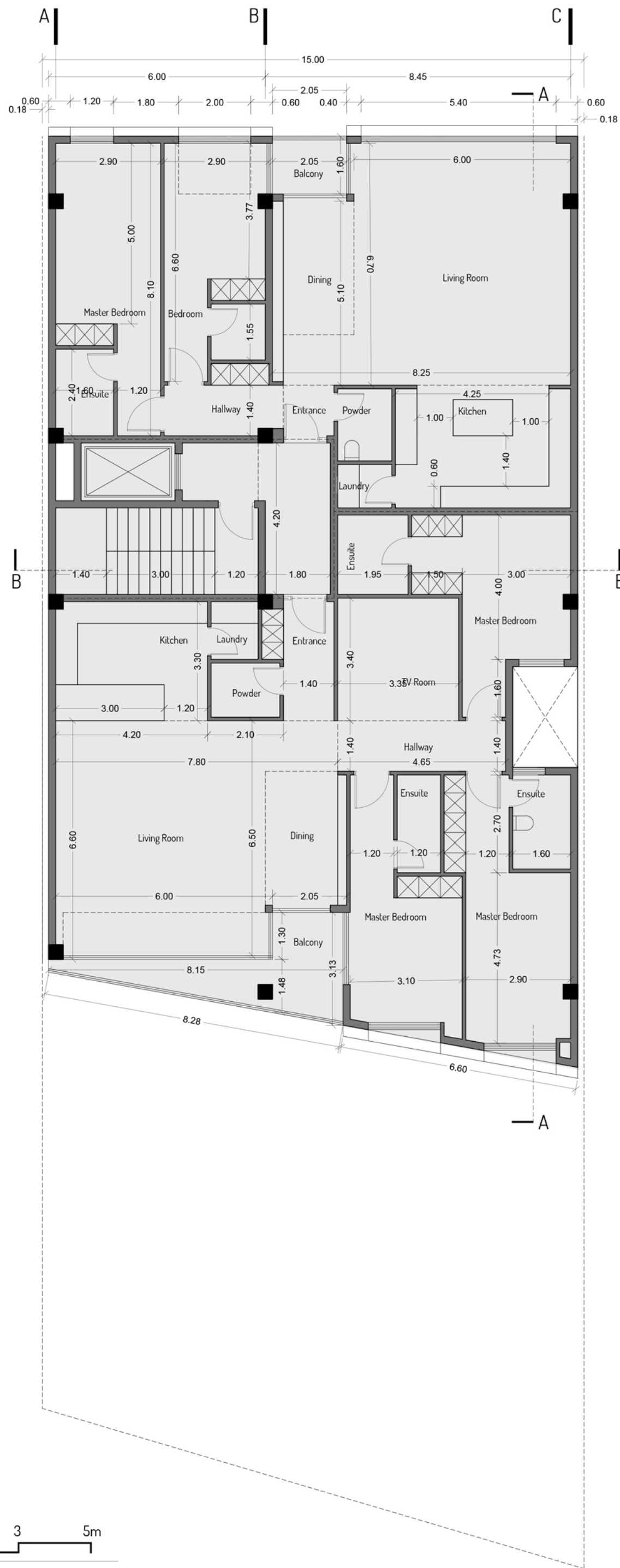

Floor Plan 5
Dimension

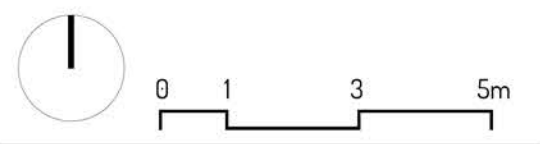
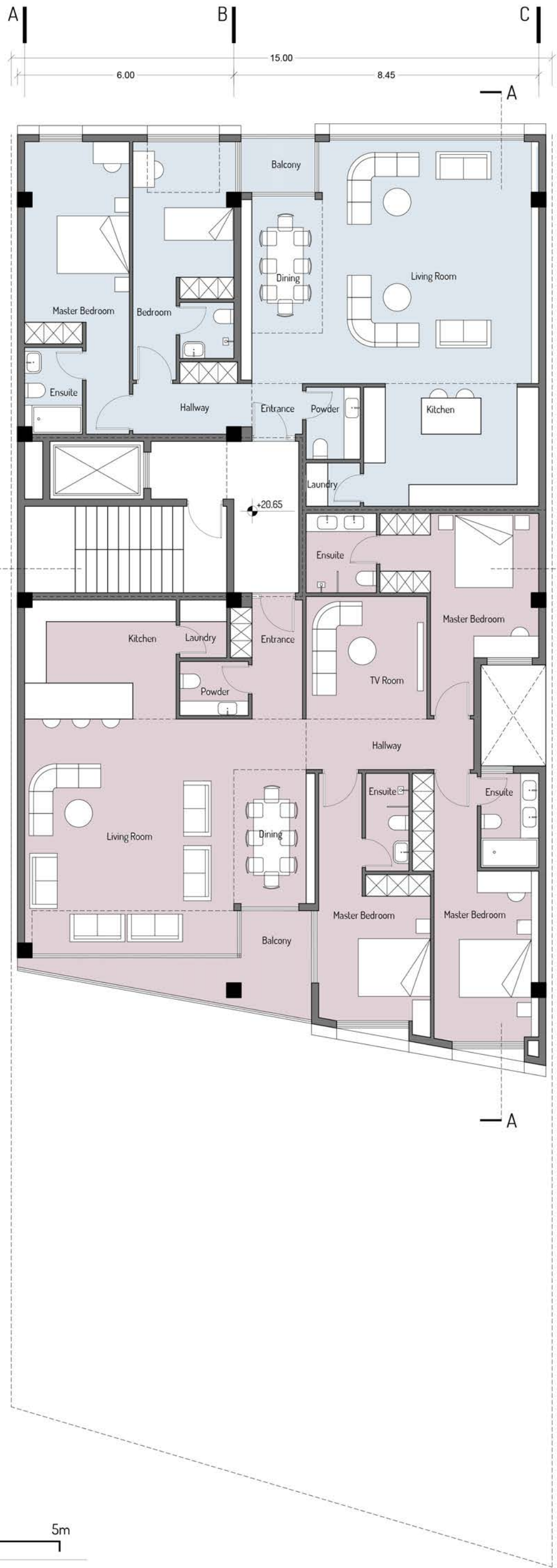

Floor Plan 5

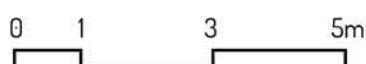
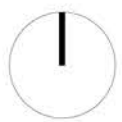
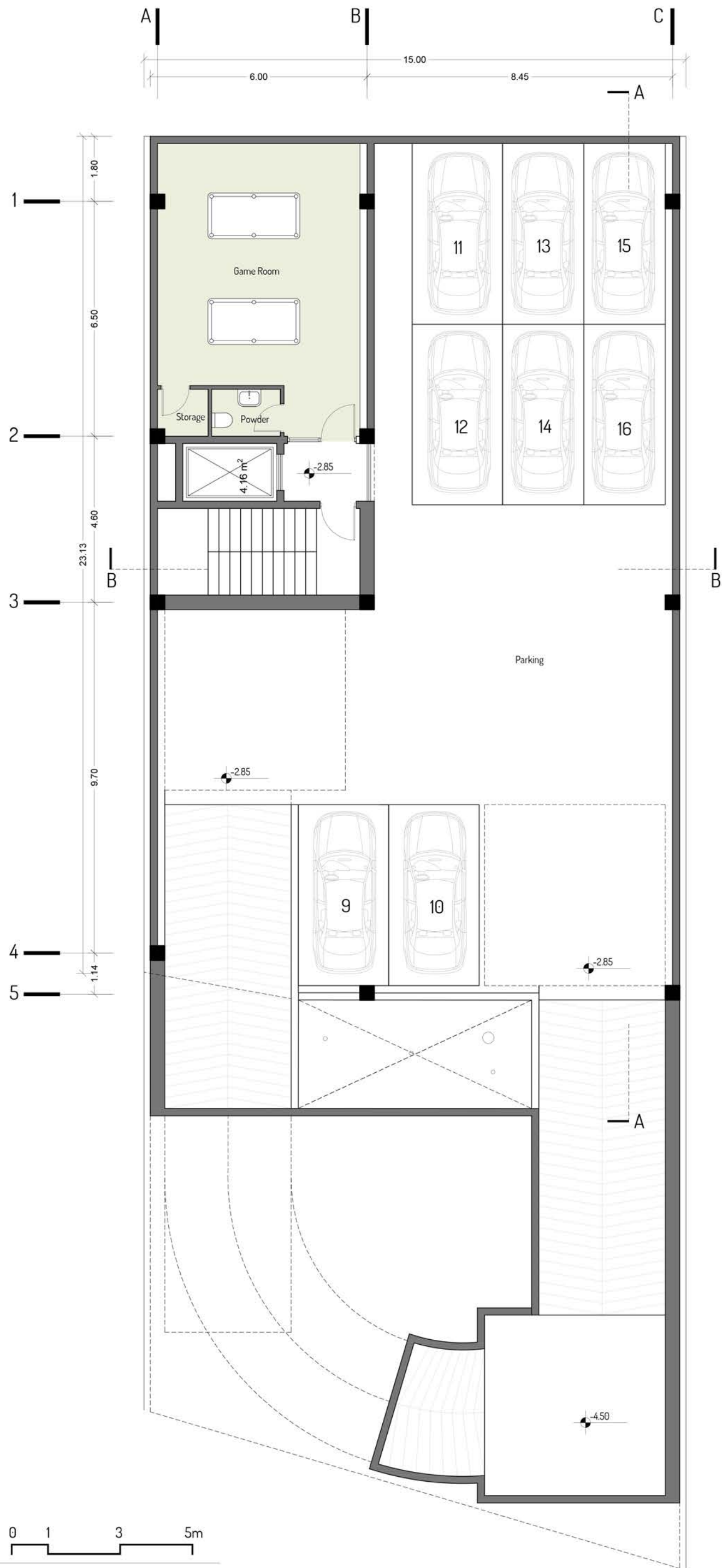

Floor Plan -1

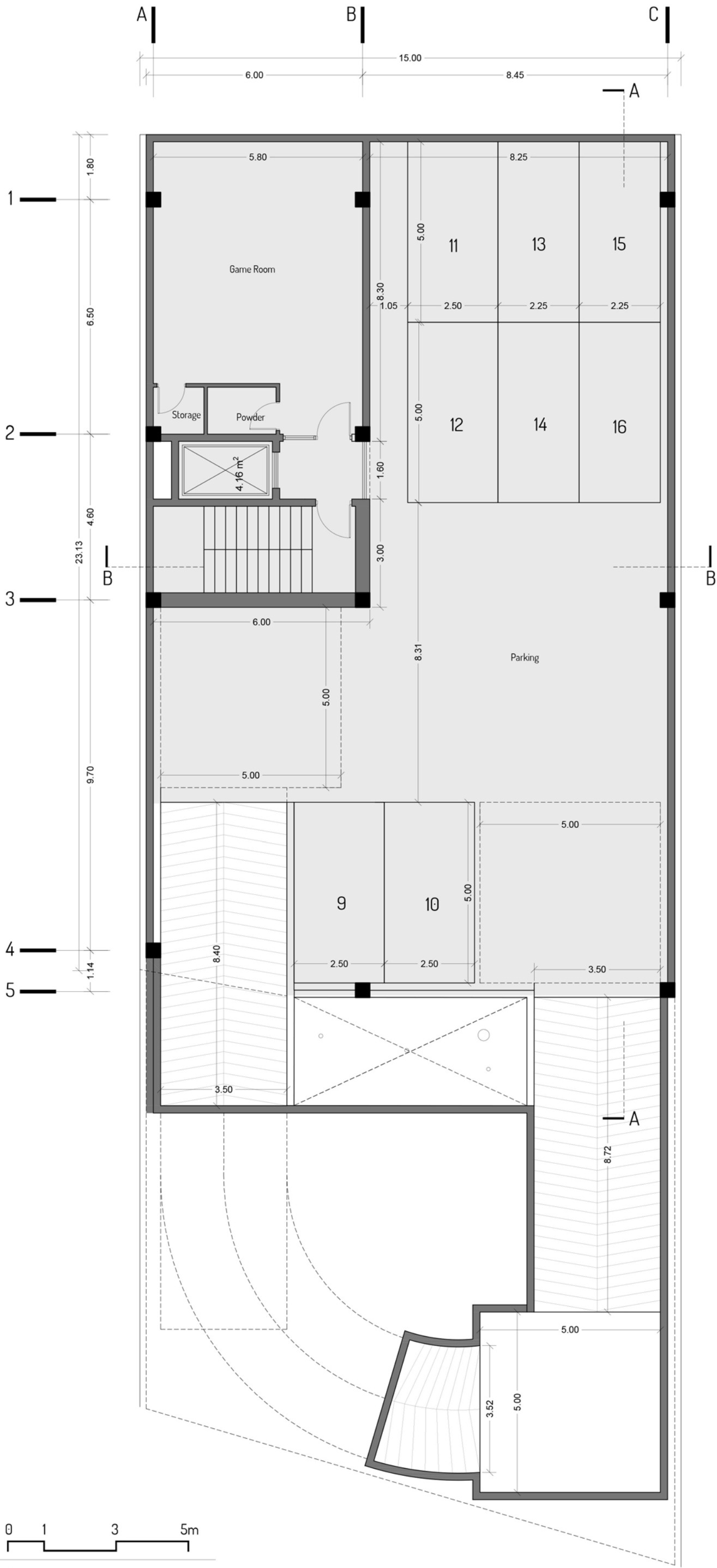

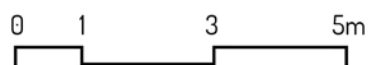
 Floor Plan -1
 Dimension

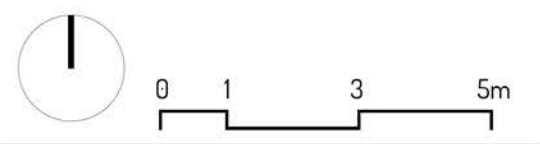
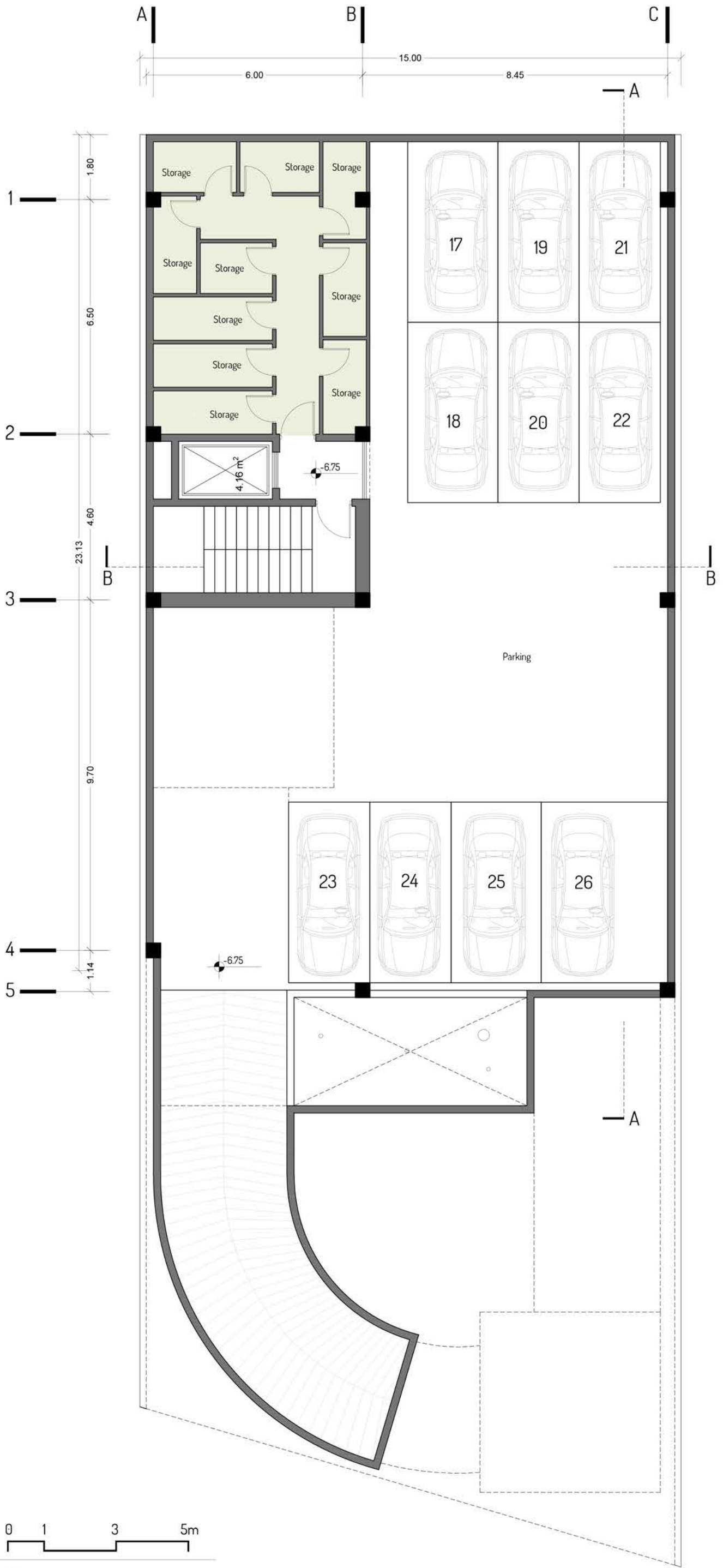

Floor Plan -2

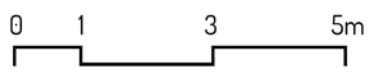
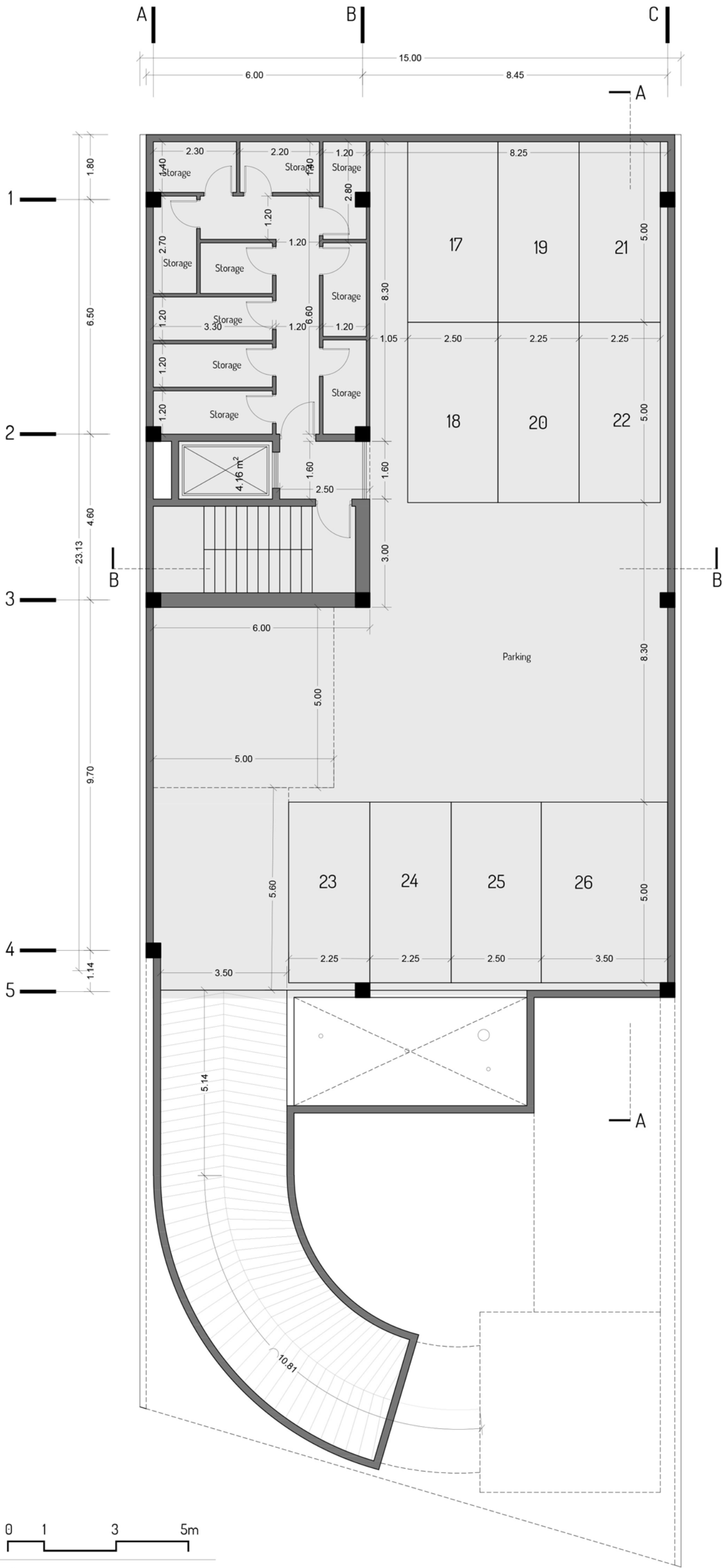

Floor Plan -2
Dimension

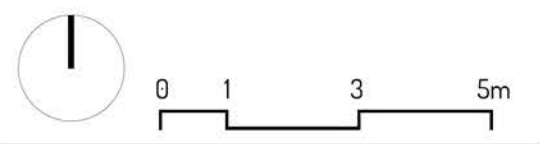

Floor Plan -3

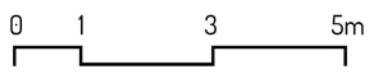
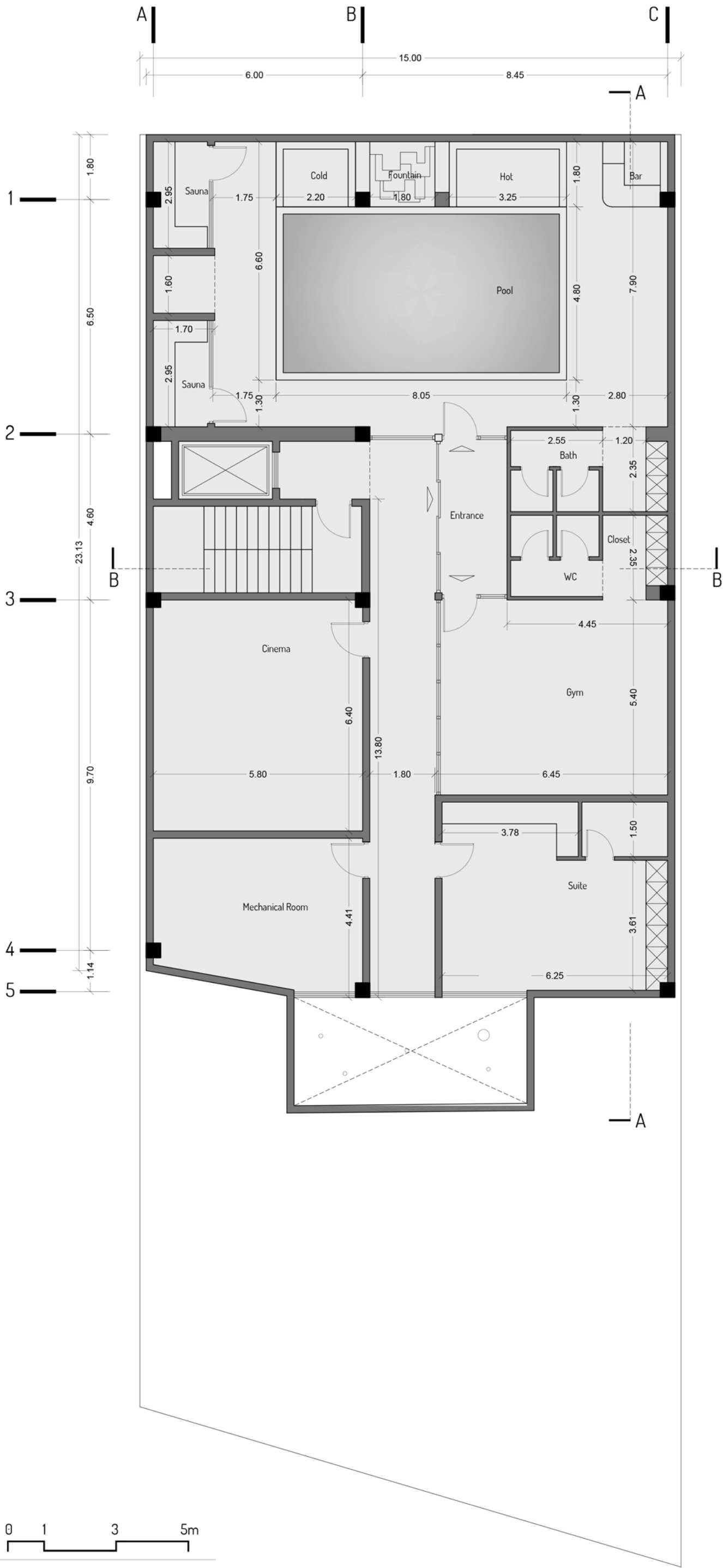

Floor Plan -3
Dimension

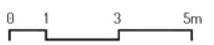
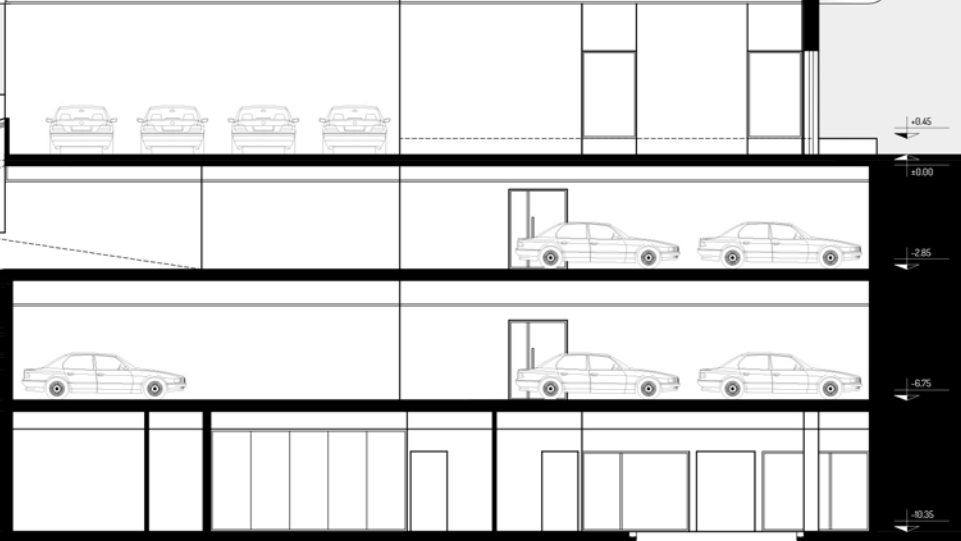
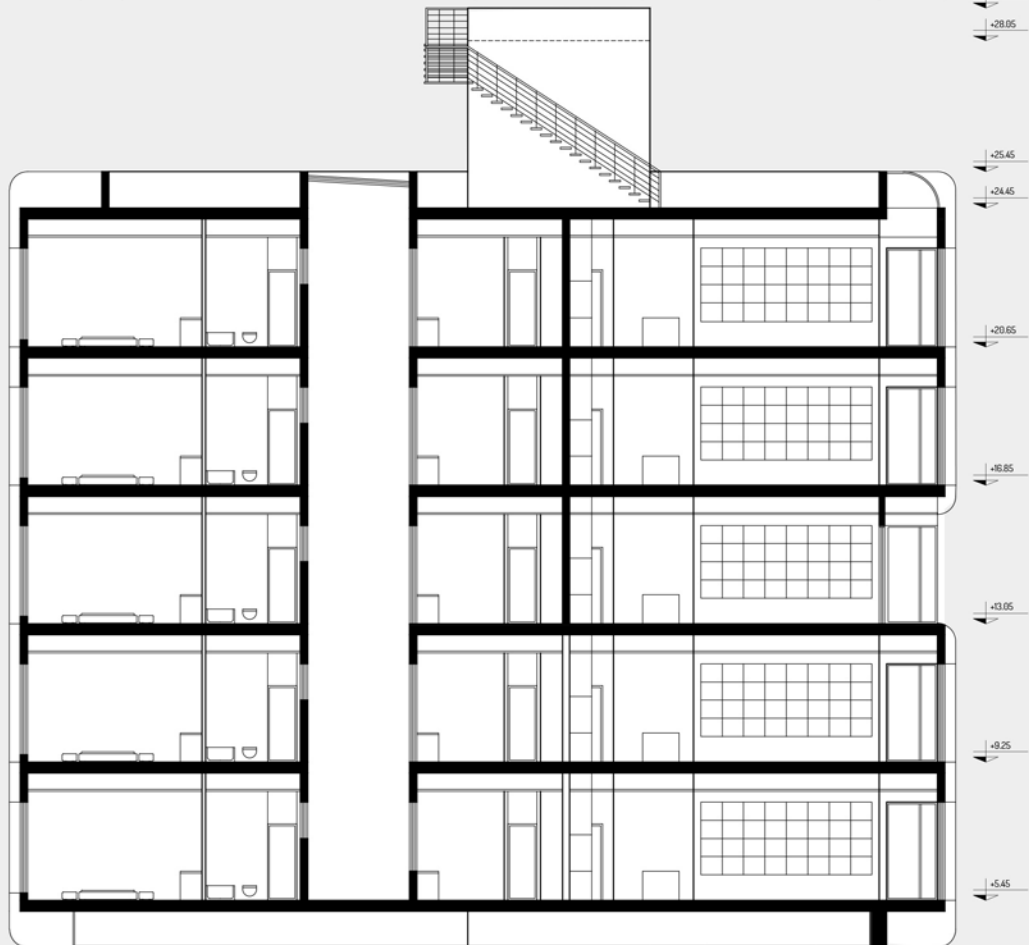

Section A-A

