



SOUTH FACE

SOUTH FACE



SOUTH FACE





SOUTH FACE



SOUTH FACE



**NORTH FACE**

NORTH FACE





NORTH FACE



Primary window

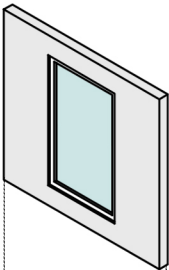

Faced extrusion

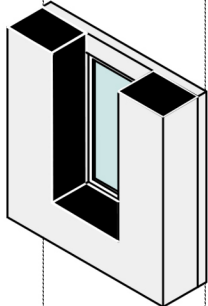

Change the surface to create the maximum window size

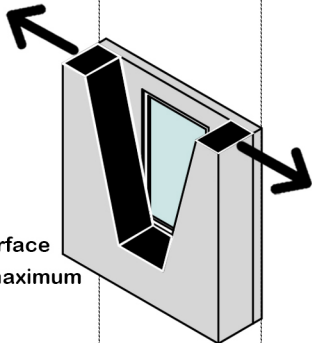

Rotate the surface to get better sunlight

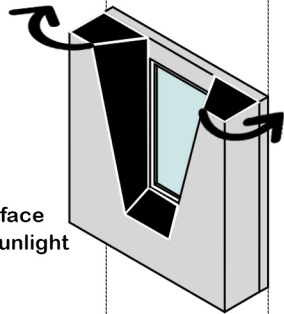

Add flowerbox

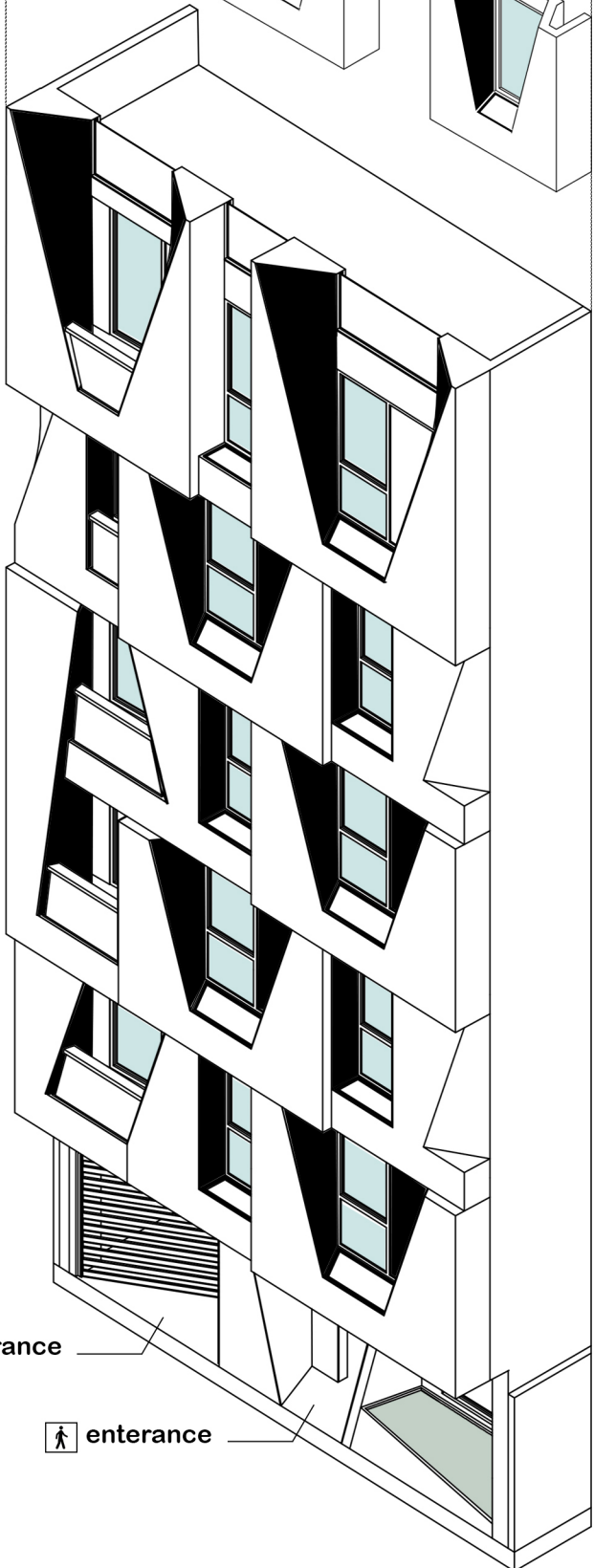
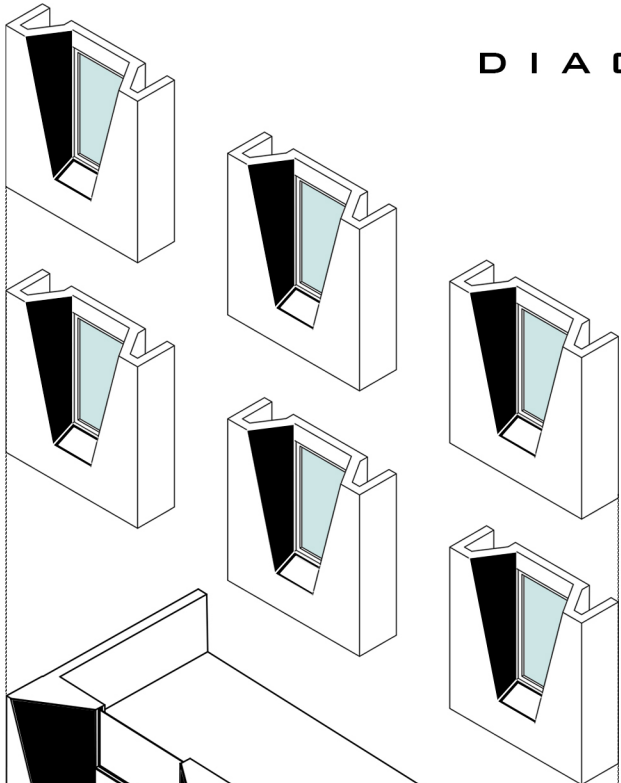
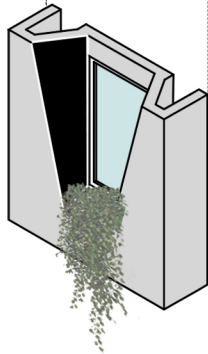

 parking entrance

 entrance