

به نام خدا
آلبوم مدارک طراحی پروژه دولت



توجیه طرح

بنا به درخواست کارفرما مبنی بر طراحی پروژه به سبک مراکشی از اصول این سبک استفاده کردیم. از اصول های این سبک می توان به قرینگی اجزا، استفاده از آب، پنجره های باریک تر ولی بلند و.... اشاره کرد.

به همین منظور در طراحی سایت، لابی و بام از عنصر قرینگی و آب استفاده شده است. همچنین اصل قرینگی و بالکن زیاد در نمای غربی و اندازه بازشوها رعایت شده است.

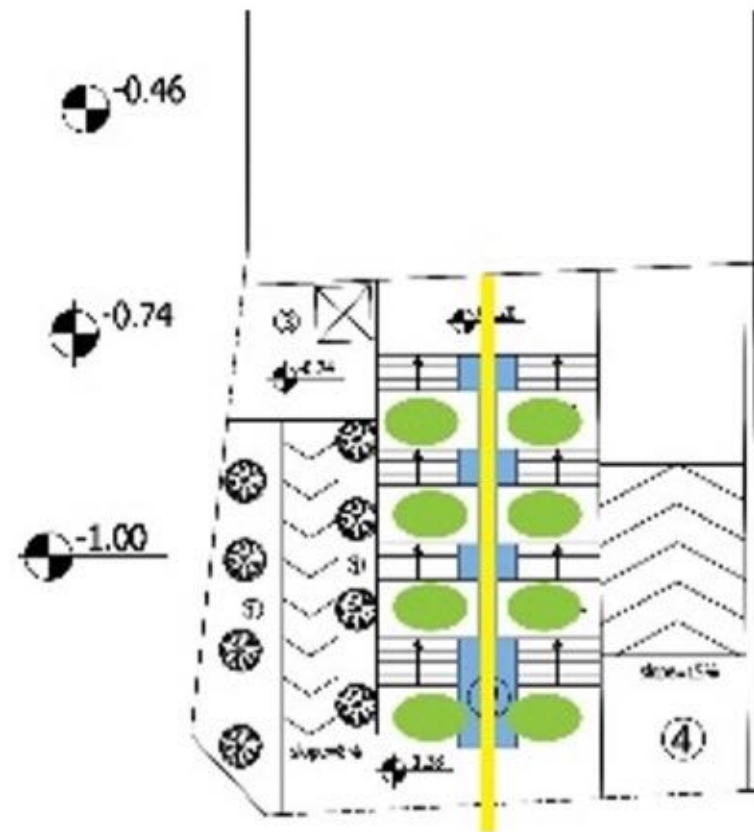
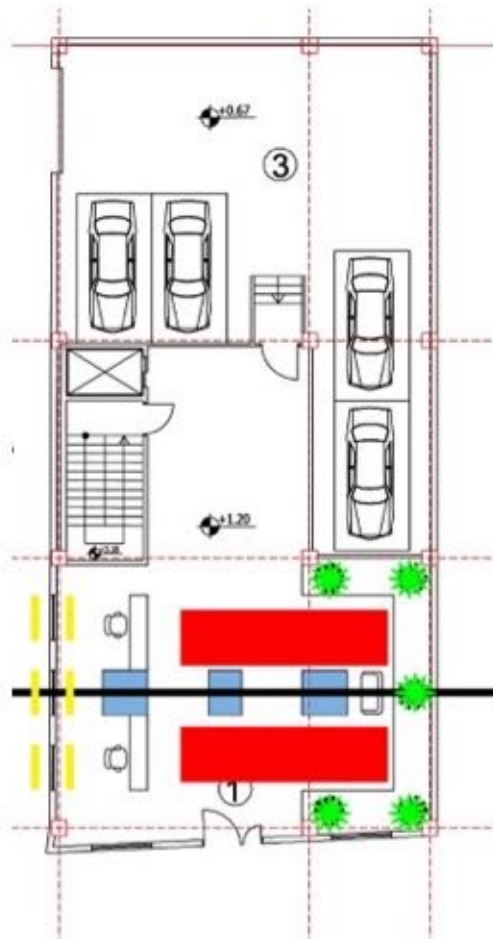
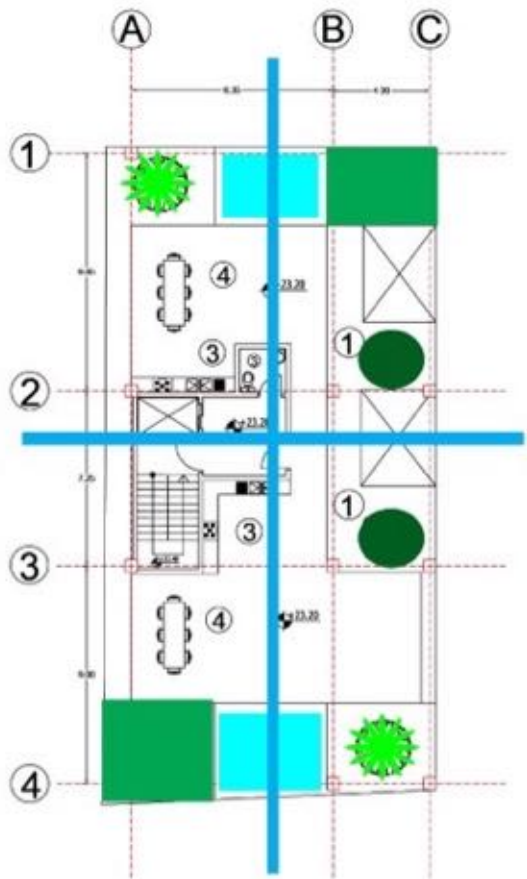

توجیه طرح پارکینگ ها

با توجه به متراژ واحد ها حداکثر 15 پارکینگ مورد نیاز بود اما کارفرما اعلام داشتند که طراحی پارکینگ مازاد مد نظر می باشد. از طرفی طول رمپ زیاد زیرزمین اول به زیرزمین دوم چالش بزرگی برای طراحی پارکینگ ها را بدنبال داشت.

به همین منظور با طراحی رمپ به صورت دو طرفه و شروع رمپ از یک سوم اولیه پلان و رعایت سرگیری ها توانستیم به فضای قابل قبولی برای پارکینگ ها دست پیدا کنیم و تعداد 20 پارکینگ برای ساختمان بدست بیاوریم. 5 پارکینگ مازاد بر نیاز ساختمان طراحی کردیم که از نکات مثبت و قابل توجه طرح است.

آلبوم مدارک

از اسلاید بعدی تمامی مدارک فنی طرح قابل مشاهده هست.
به ترتیب از سایت پلان آغاز و به پلان بام منتهی می شود.

بخش اول تمامی پلان ها به صورت مبلمان و بخش دوم تمامی پلان های اندازه گذاری قرار داده شده اند.

TARH 2 TARH

DOLLAT PROJECT

DESIGN BY
DELFIORÉ
ARCHITECTURE
GROUP

ARCHITECT
AMIRALI SADEGHII

SCALE:1/100

SITE PLAN

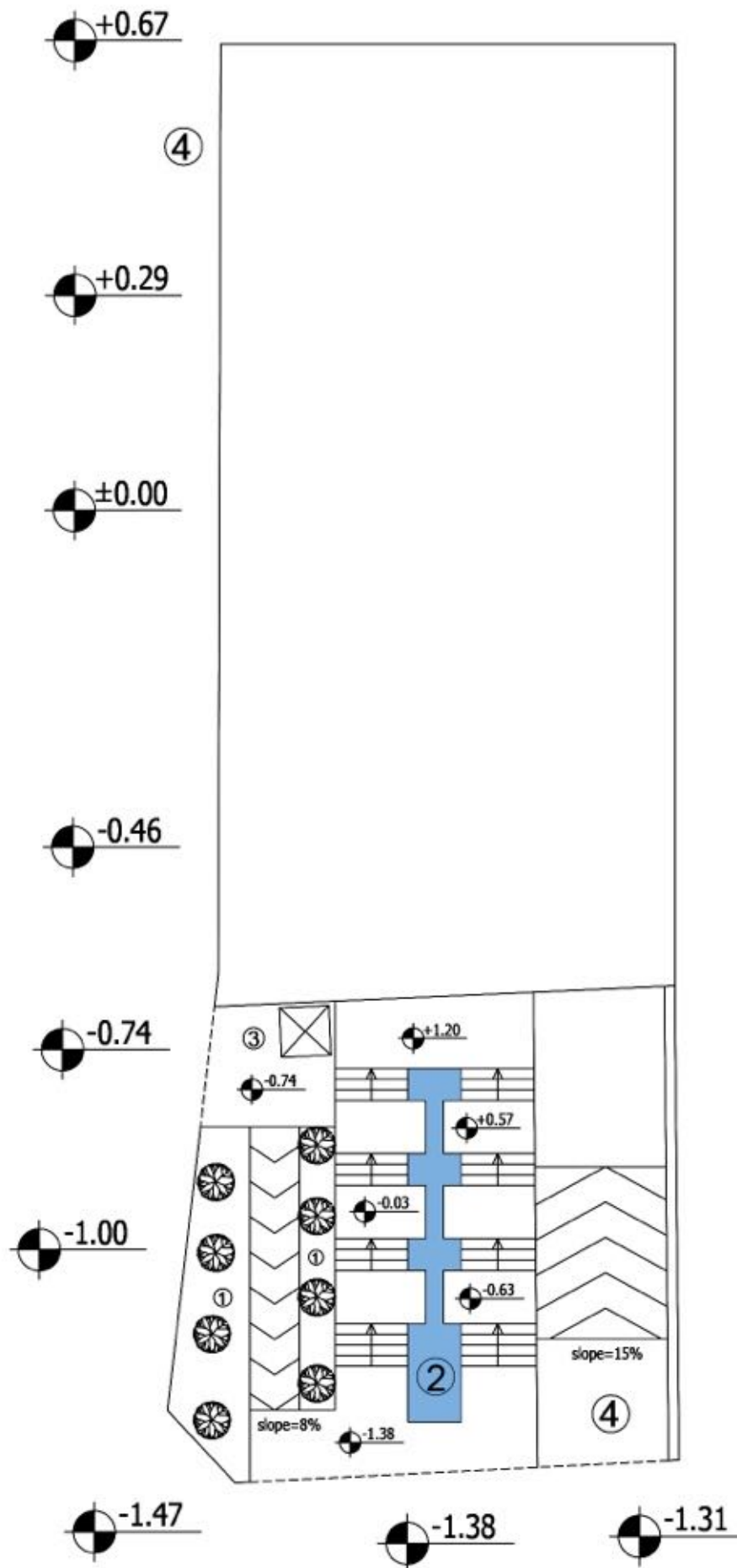

- ① GARDEN
- ② POND
- ③ DISABLED ELEVATOR
- ④ PARKING ENTRANCE

TARH 2 TARH

DOLLAT PROJECT

DESIGN BY
DELFIORÉ
ARCHITECTURE
GROUP

ARCHITECT
AMIRALI SADEGHII

SCALE:1/100

GROUND FLOOR
PLAN

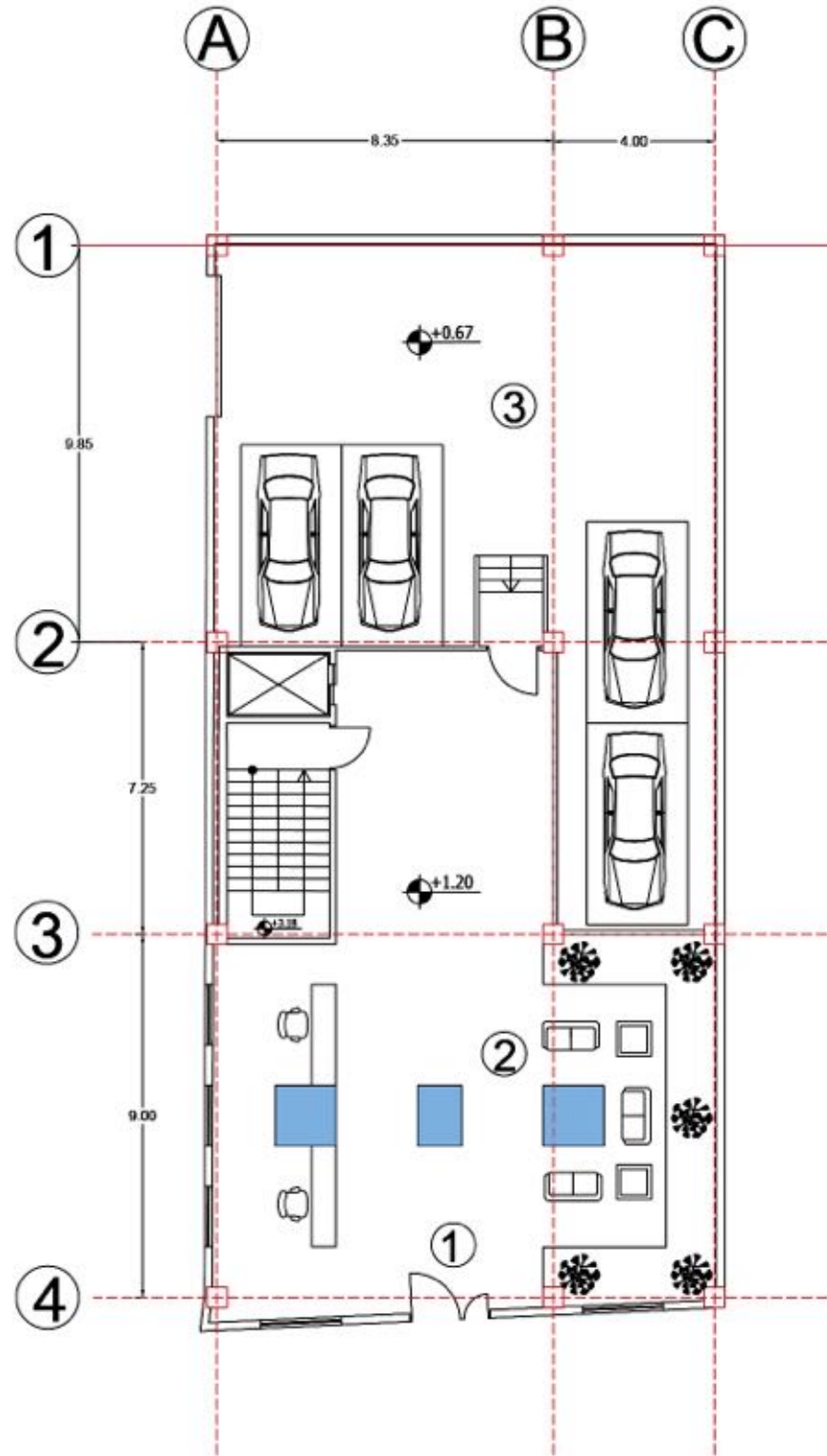

- ① MAIN ENTRANCE
- ② LOBBY
- ③ PARKING

TARH 2 TARH

DOLLAT PROJECT

DESIGN BY
DELFIORÉ
ARCHITECTURE
GROUP

ARCHITECT
AMIRALI SADEGHII

SCALE:1/100

UNDERGROUND 1
FLOOR PLAN

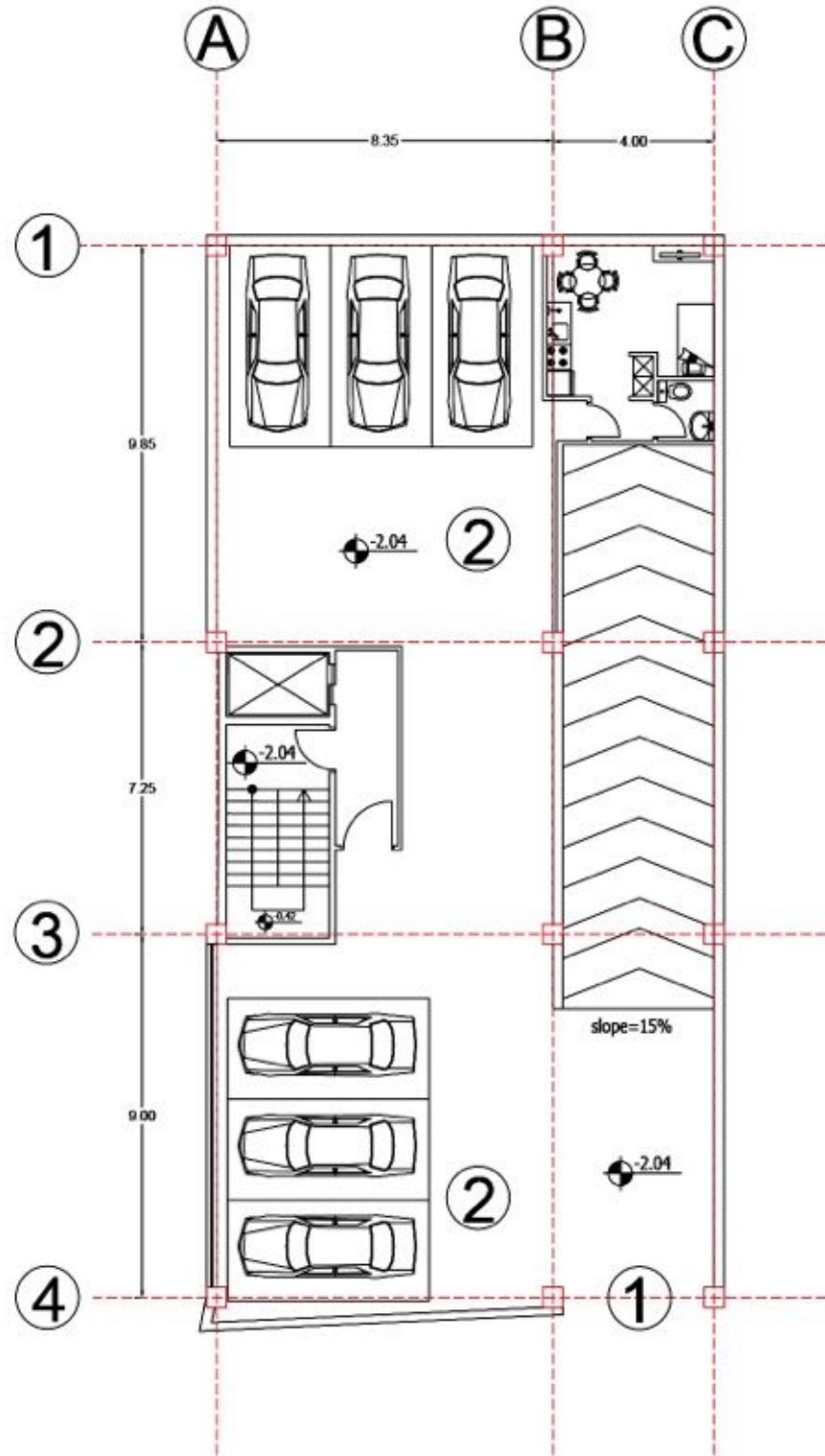

- ① MAIN ENTRANCE
- ② PARKING
- ③ JANITOR ROOM

TARH 2 TARH

DOLLAT PROJECT

DESIGN BY
DELFIORÉ
ARCHITECTURE
GROUP

ARCHITECT
AMIRALI SADEGHII

SCALE:1/100

UNDERGROUND 2
FLOOR PLAN

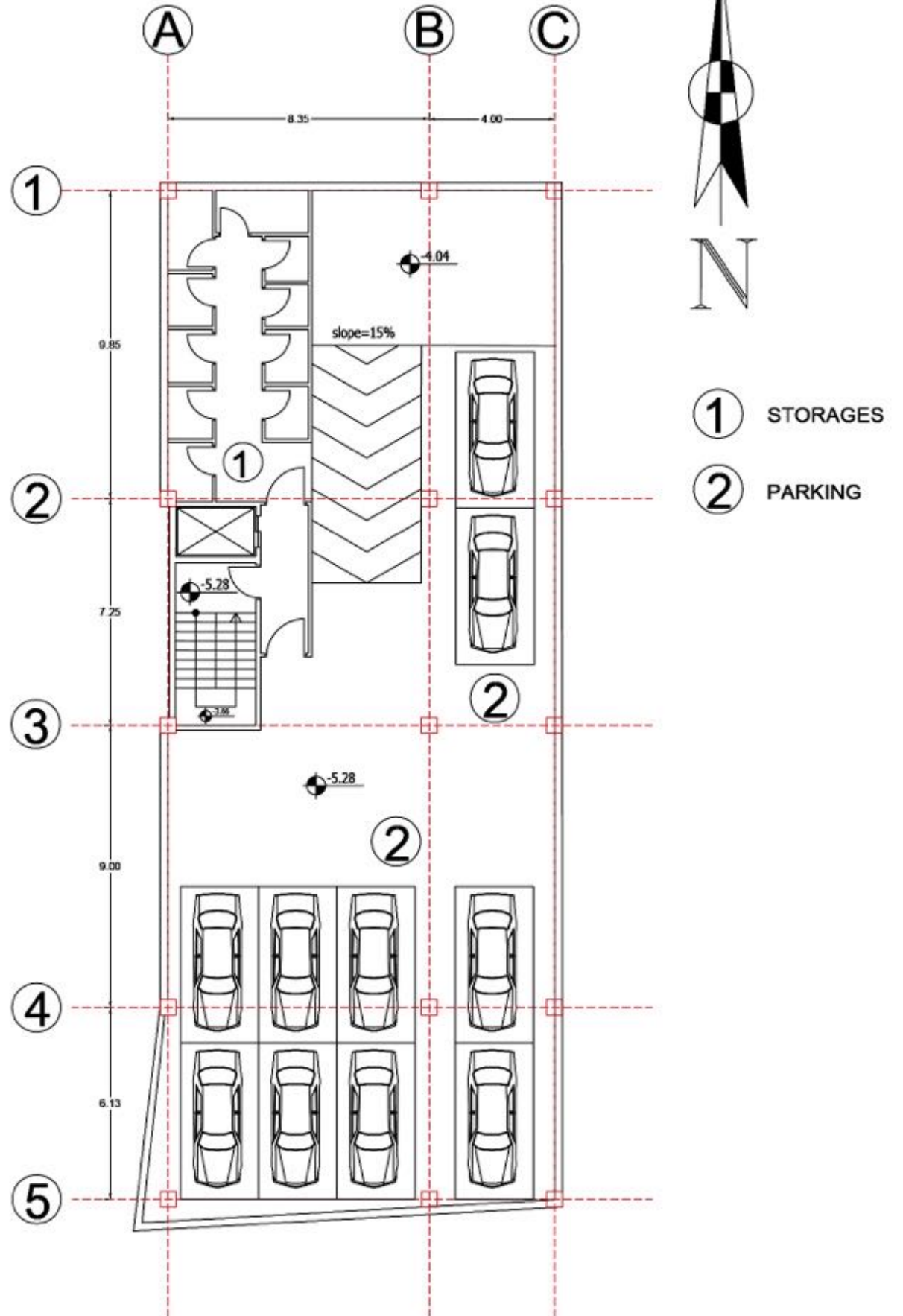

TARH 2 TARH

DOLLAT PROJECT

DESIGN BY
DELFIORÉ
ARCHITECTURE
GROUP

ARCHITECT
AMIRALI SADEGHII

SCALE:1/100

FIRST FLOOR
PLAN

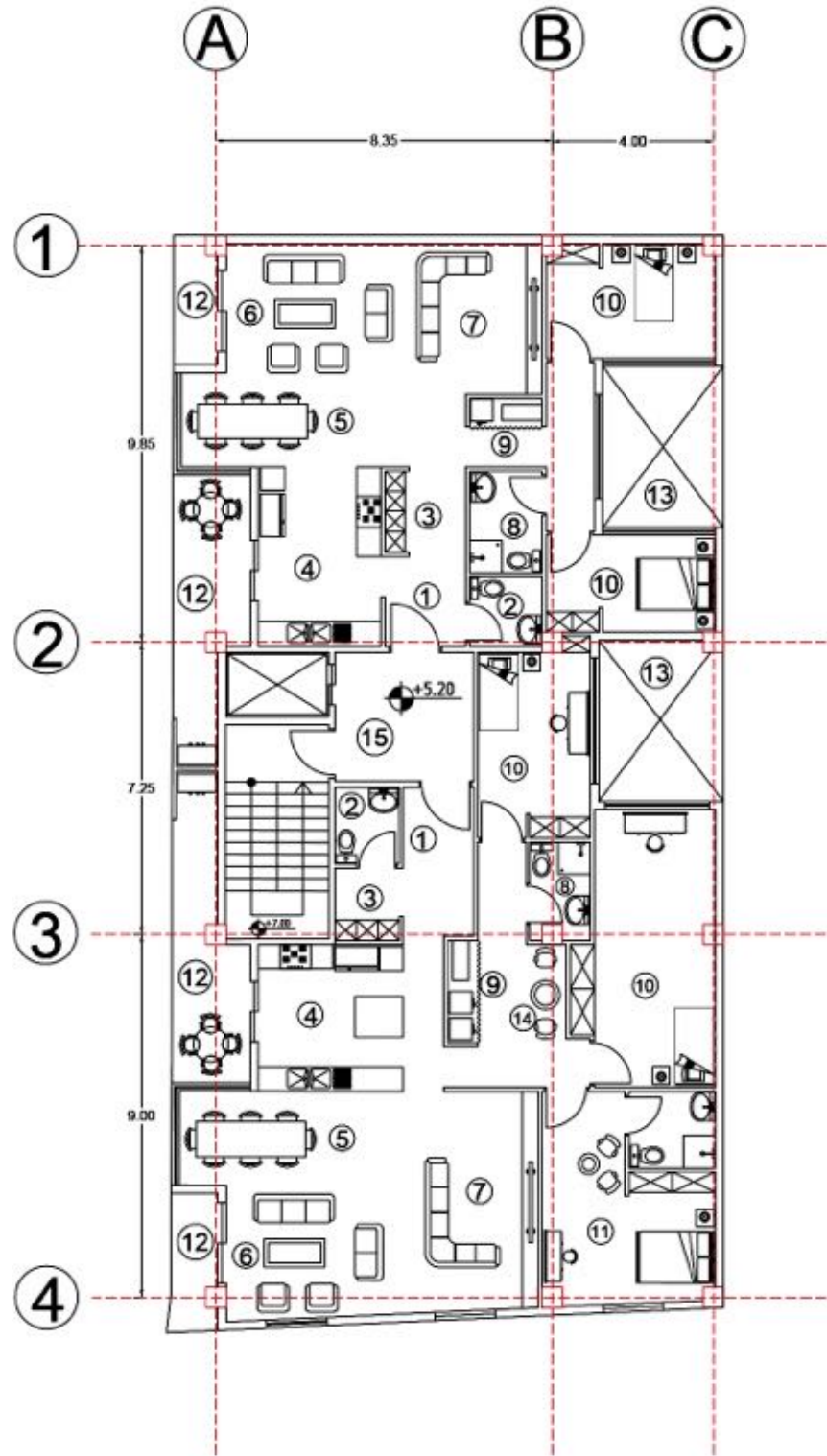

- ① ENTRANCE
- ② RESTROOM
- ③ CLOSET
- ④ KITCHEN
- ⑤ DINNING ROOM
- ⑥ LIVING ROOM
- ⑦ TV ROOM
- ⑧ BATHROOM
- ⑨ LAUNDRY
- ⑩ BEDROOM
- ⑪ MASTER BEDROOM
- ⑫ BALCONY
- ⑬ PATIO
- ⑭ PRIVATE LOUNGE
- ⑮ PUBLIC SPACE

TARH 2 TARH

DOLLAT PROJECT

DESIGN BY
DELFIORÉ
ARCHITECTURE
GROUP

ARCHITECT
AMIRALI SADEGHII

SCALE:1/100

SECOND FLOOR
PLAN

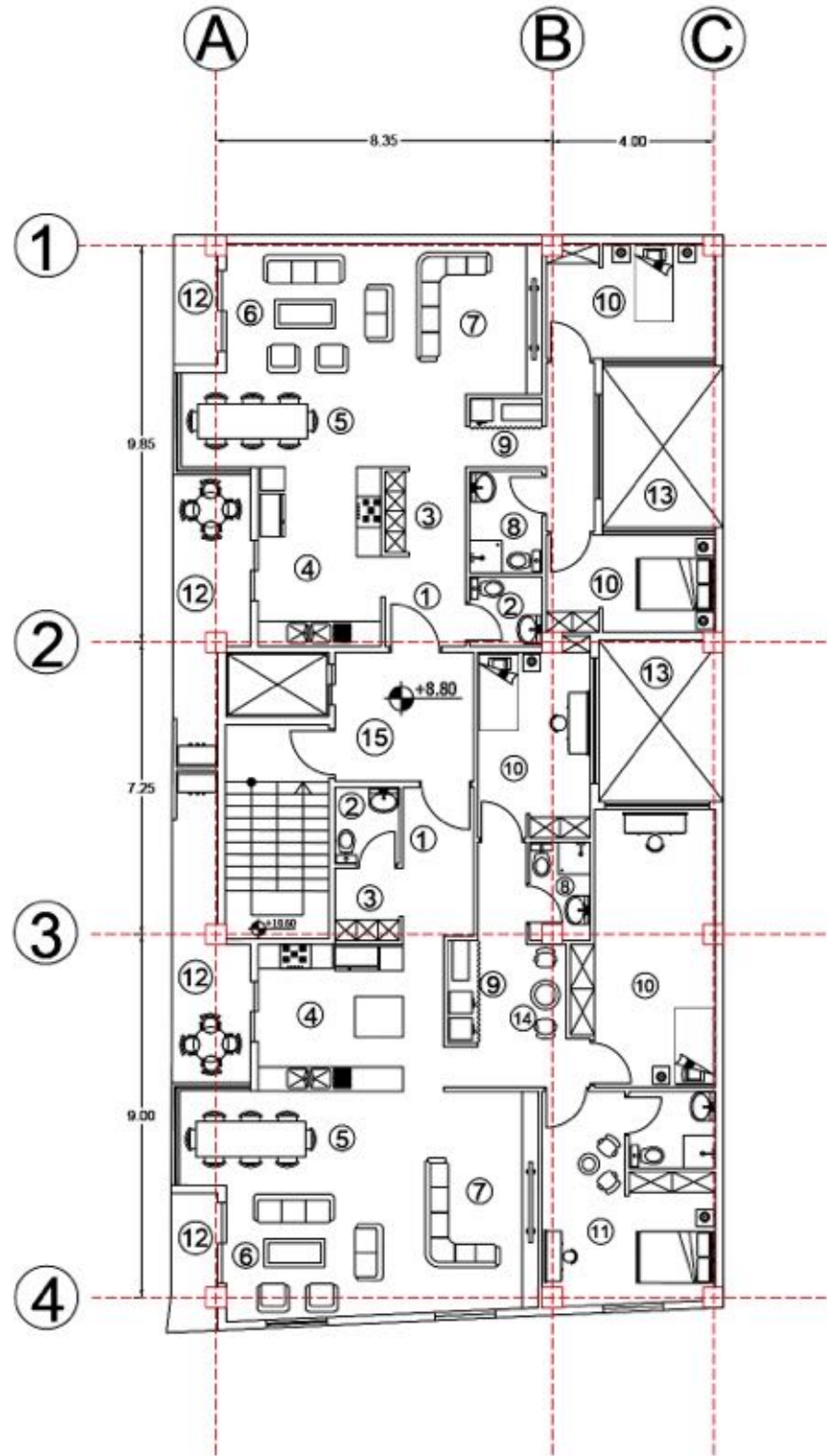

- ① ENTRANCE
- ② RESTROOM
- ③ CLOSET
- ④ KITCHEN
- ⑤ DINNING ROOM
- ⑥ LIVING ROOM
- ⑦ TV ROOM
- ⑧ BATHROOM
- ⑨ LAUNDRY
- ⑩ BEDROOM
- ⑪ MASTER BEDROOM
- ⑫ BALCONY
- ⑬ PATIO
- ⑭ PRIVATE LOUNGE
- ⑮ PUBLIC SPACE

TARH 2 TARH

DOLLAT PROJECT

DESIGN BY
DELFIORÉ
ARCHITECTURE
GROUP

ARCHITECT
AMIRALI SADEGHII

SCALE:1/100

THIRD FLOOR
PLAN

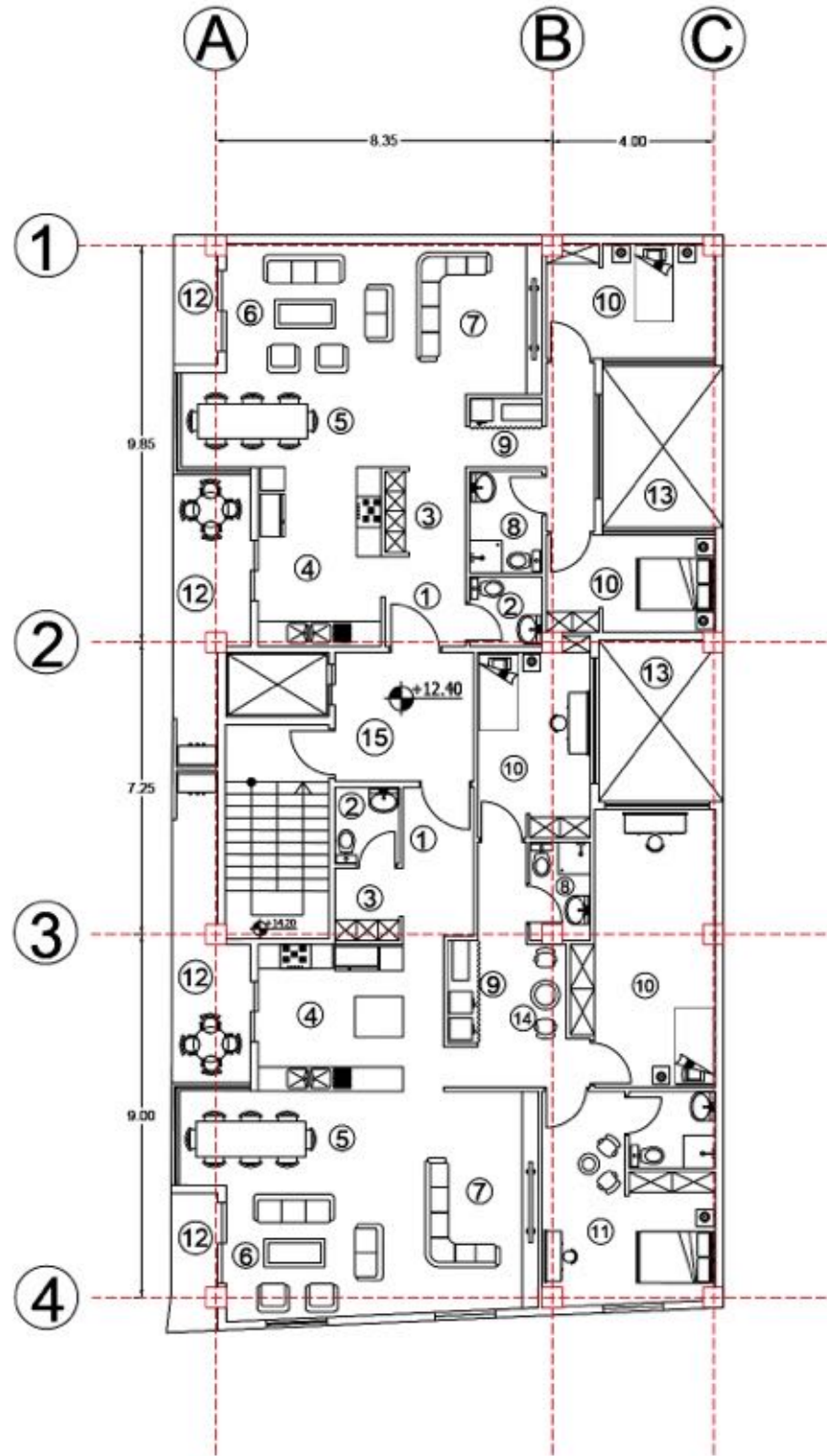

- ① ENTRANCE
- ② RESTROOM
- ③ CLOSET
- ④ KITCHEN
- ⑤ DINNING ROOM
- ⑥ LIVING ROOM
- ⑦ TV ROOM
- ⑧ BATHROOM
- ⑨ LAUNDRY
- ⑩ BEDROOM
- ⑪ MASTER BEDROOM
- ⑫ BALCONY
- ⑬ PATIO
- ⑭ PRIVATE LOUNGE
- ⑮ PUBLIC SPACE

TARH 2 TARH

DOLLAT PROJECT

DESIGN BY
DELFIORÉ
ARCHITECTURE
GROUP

ARCHITECT
AMIRALI SADEGHII

SCALE:1/100

FOURTH FLOOR
PLAN

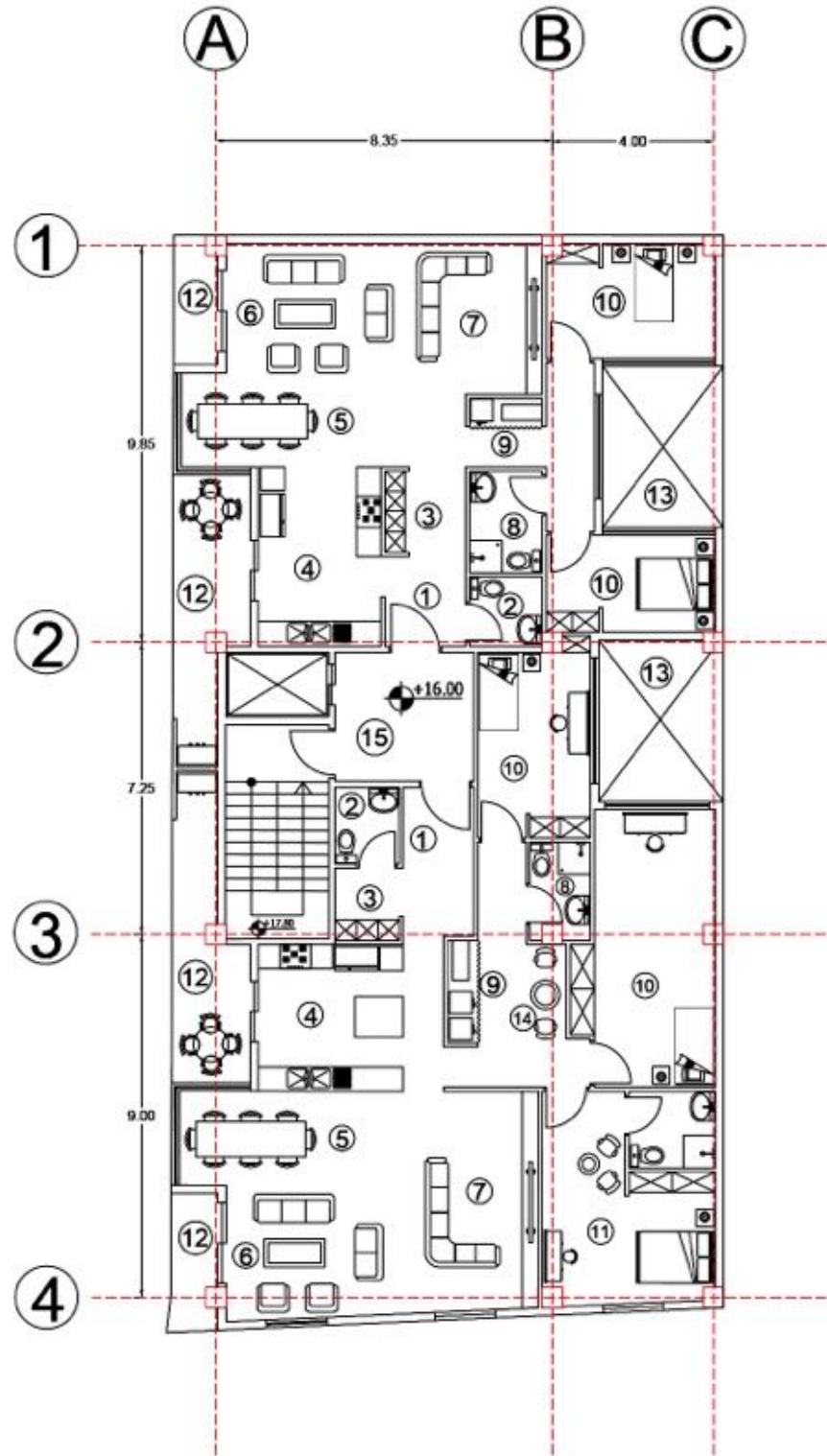

- ① ENTRANCE
- ② RESTROOM
- ③ CLOSET
- ④ KITCHEN
- ⑤ DINNING ROOM
- ⑥ LIVING ROOM
- ⑦ TV ROOM
- ⑧ BATHROOM
- ⑨ LAUNDRY
- ⑩ BEDROOM
- ⑪ MASTER BEDROOM
- ⑫ BALCONY
- ⑬ PATIO
- ⑭ PRIVATE LOUNGE
- ⑮ PUBLIC SPACE

TARH 2 TARH

DOLLAT PROJECT

DESIGN BY
DELFIORÉ
ARCHITECTURE
GROUP

ARCHITECT
AMIRALI SADEGHII

SCALE:1/100

FIFTH FLOOR
PLAN

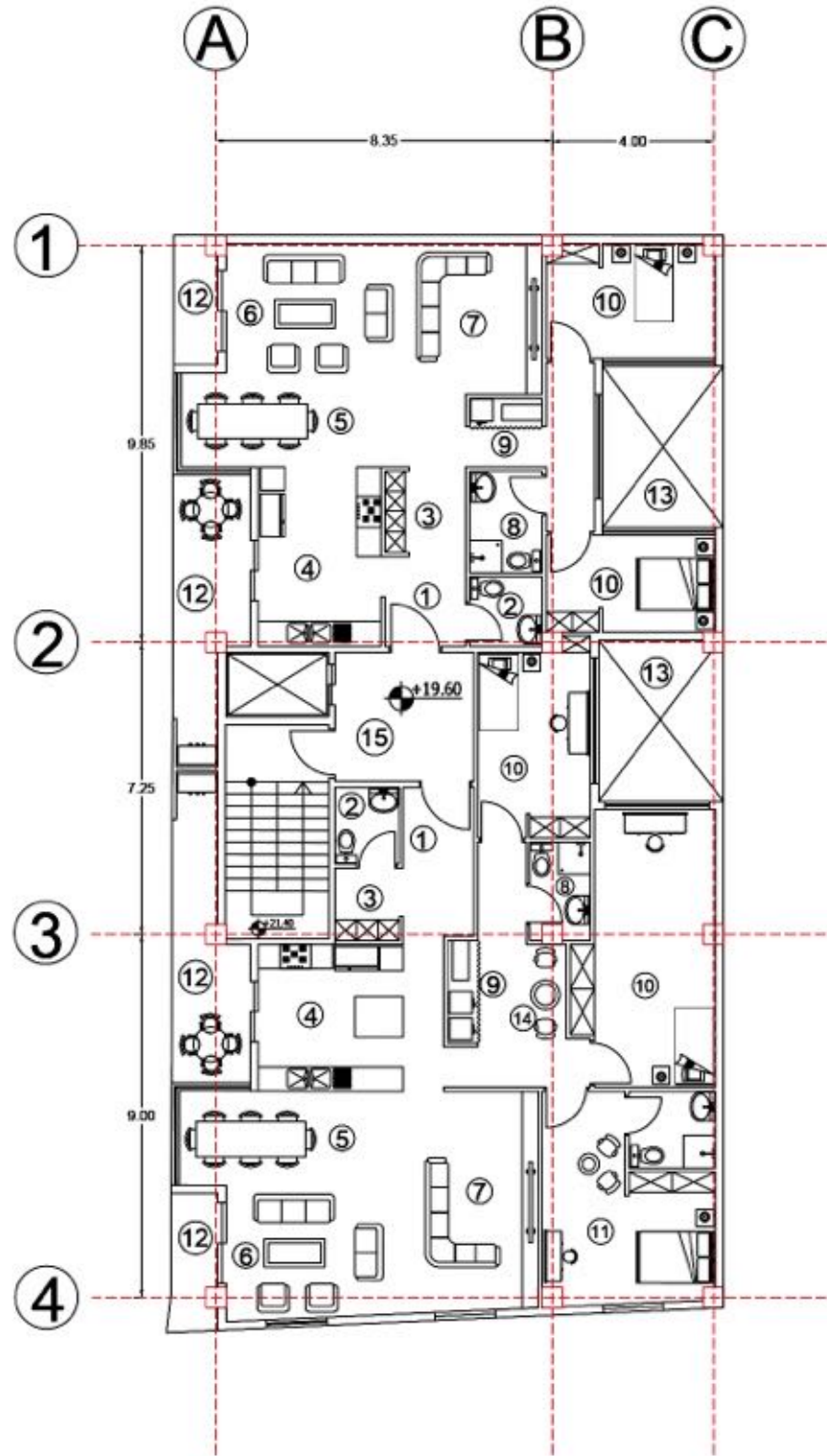

- ① ENTRANCE
- ② RESTROOM
- ③ CLOSET
- ④ KITCHEN
- ⑤ DINNING ROOM
- ⑥ LIVING ROOM
- ⑦ TV ROOM
- ⑧ BATHROOM
- ⑨ LAUNDRY
- ⑩ BEDROOM
- ⑪ MASTER BEDROOM
- ⑫ BALCONY
- ⑬ PATIO
- ⑭ PRIVATE LOUNGE
- ⑮ PUBLIC SPACE

TARH 2 TARH

DOLLAT PROJECT

DESIGN BY
DELFIORÉ
ARCHITECTURE
GROUP

ARCHITECT
AMIRALI SADEGHII

SCALE:1/100

ROOF FLOOR
PLAN

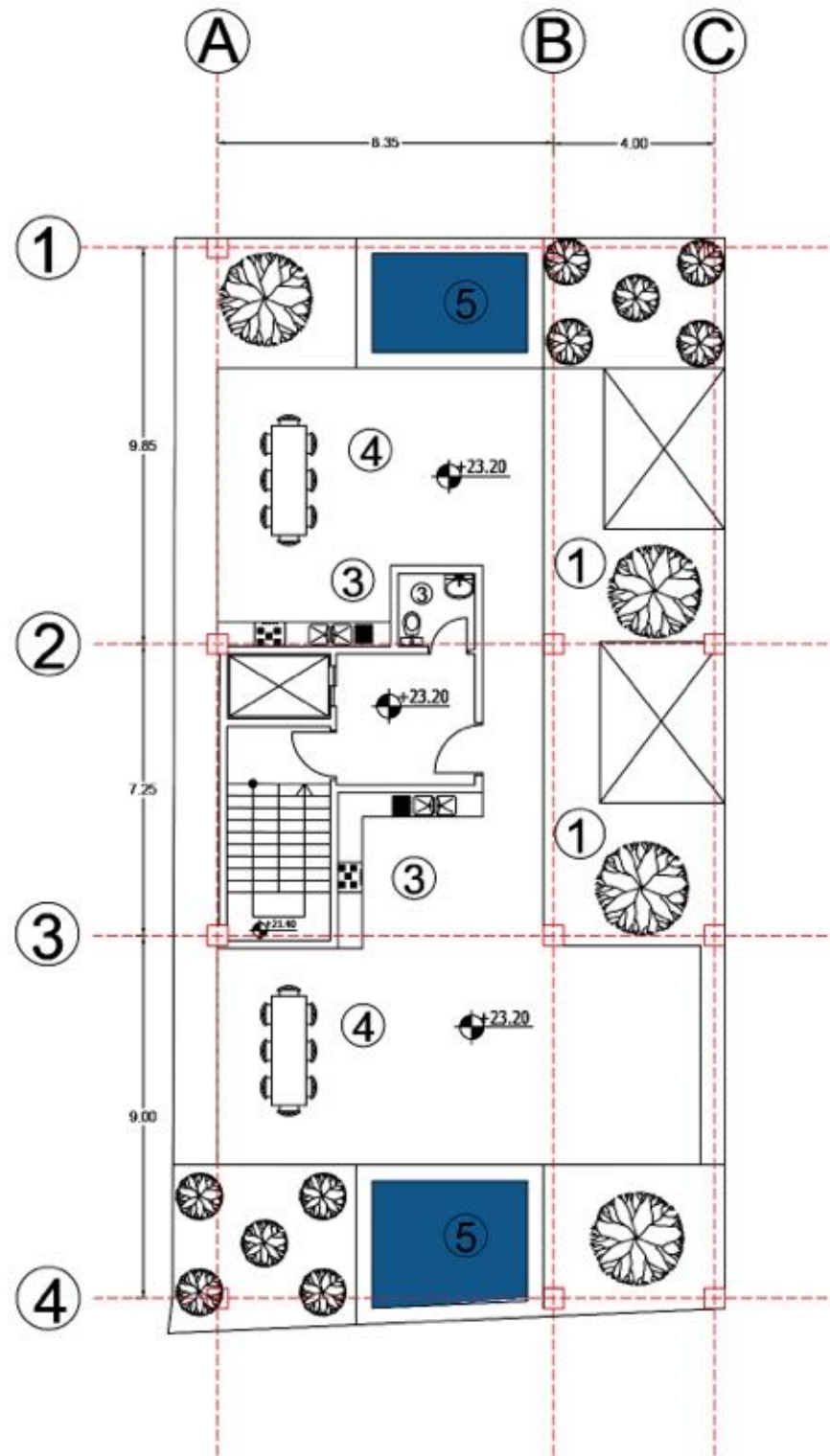

TARH 2 TARH

DOLLAT PROJECT

DESIGN BY
DELFIORÉ
ARCHITECTURE
GROUP

ARCHITECT
AMIRALI SADEGHII

SCALE:1/100

SITE PLAN
DIMENSIONS

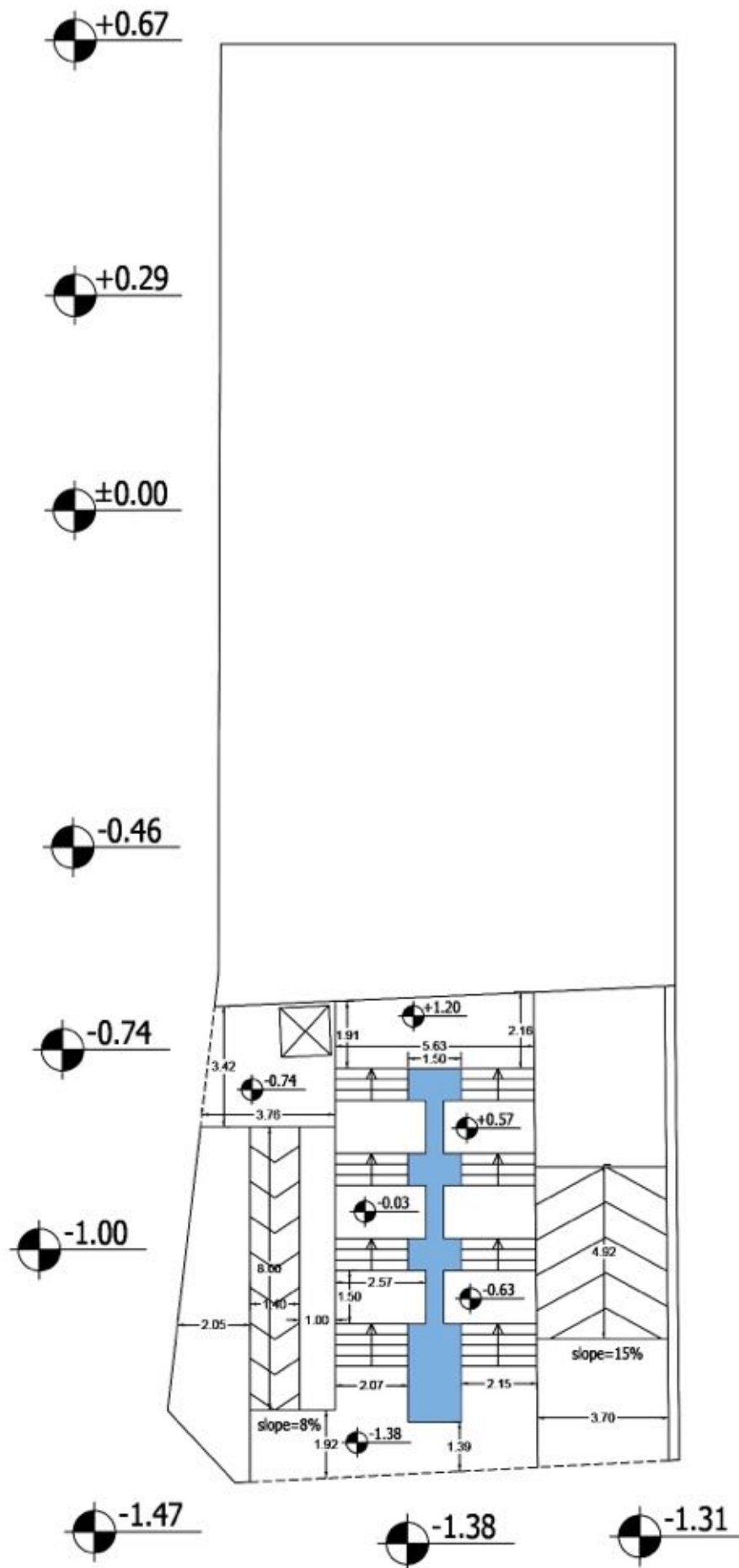

TARH 2 TARH

DOLLAT PROJECT

DESIGN BY
DELFIORÉ
ARCHITECTURE
GROUP

ARCHITECT
AMIRALI SADEGHII

SCALE:1/100

GROUND FLOOR
PLAN

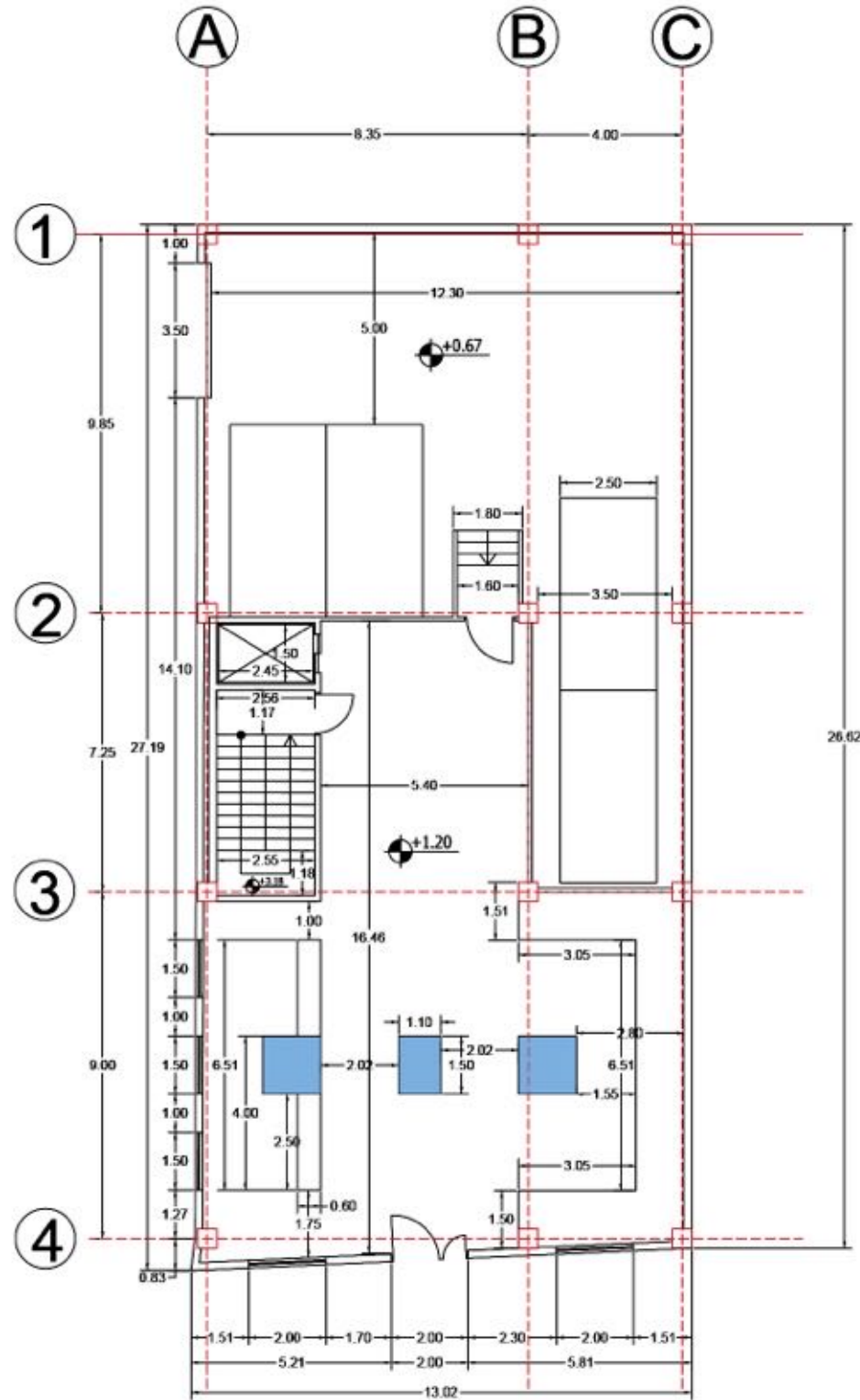

TARH 2 TARH

DOLLAT PROJECT

DESIGN BY
DELFIORÉ
ARCHITECTURE
GROUP

ARCHITECT
AMIRALI SADEGHII

SCALE:1/100

UNDERGROUND 1
FLOOR PLAN

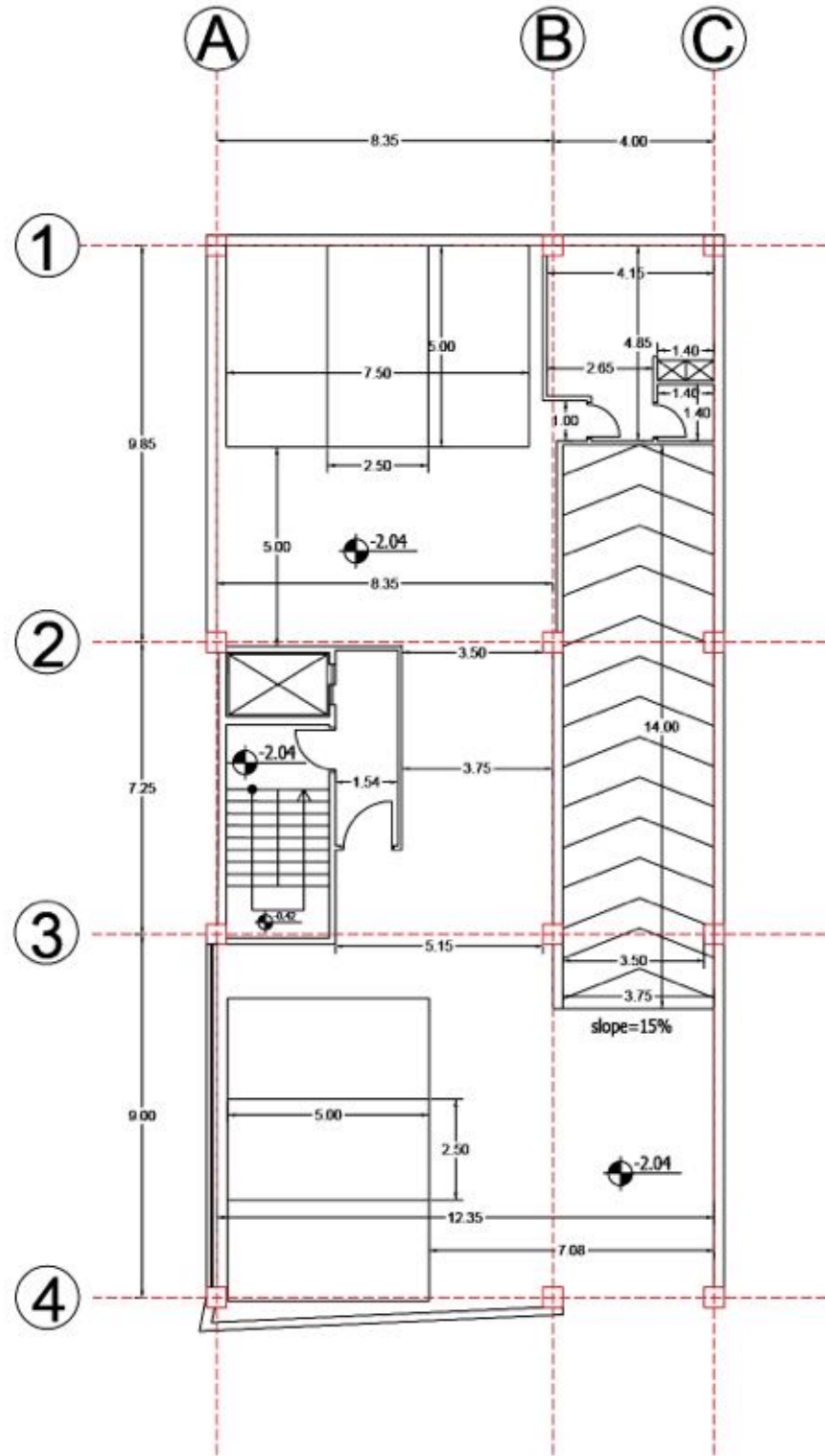

TARH 2 TARH

DOLLAT PROJECT

DESIGN BY
DELFIORÉ
ARCHITECTURE
GROUP

ARCHITECT
AMIRALI SADEGHII

SCALE:1/100

UNDERGROUND 2
FLOOR DIMENSION
PLAN

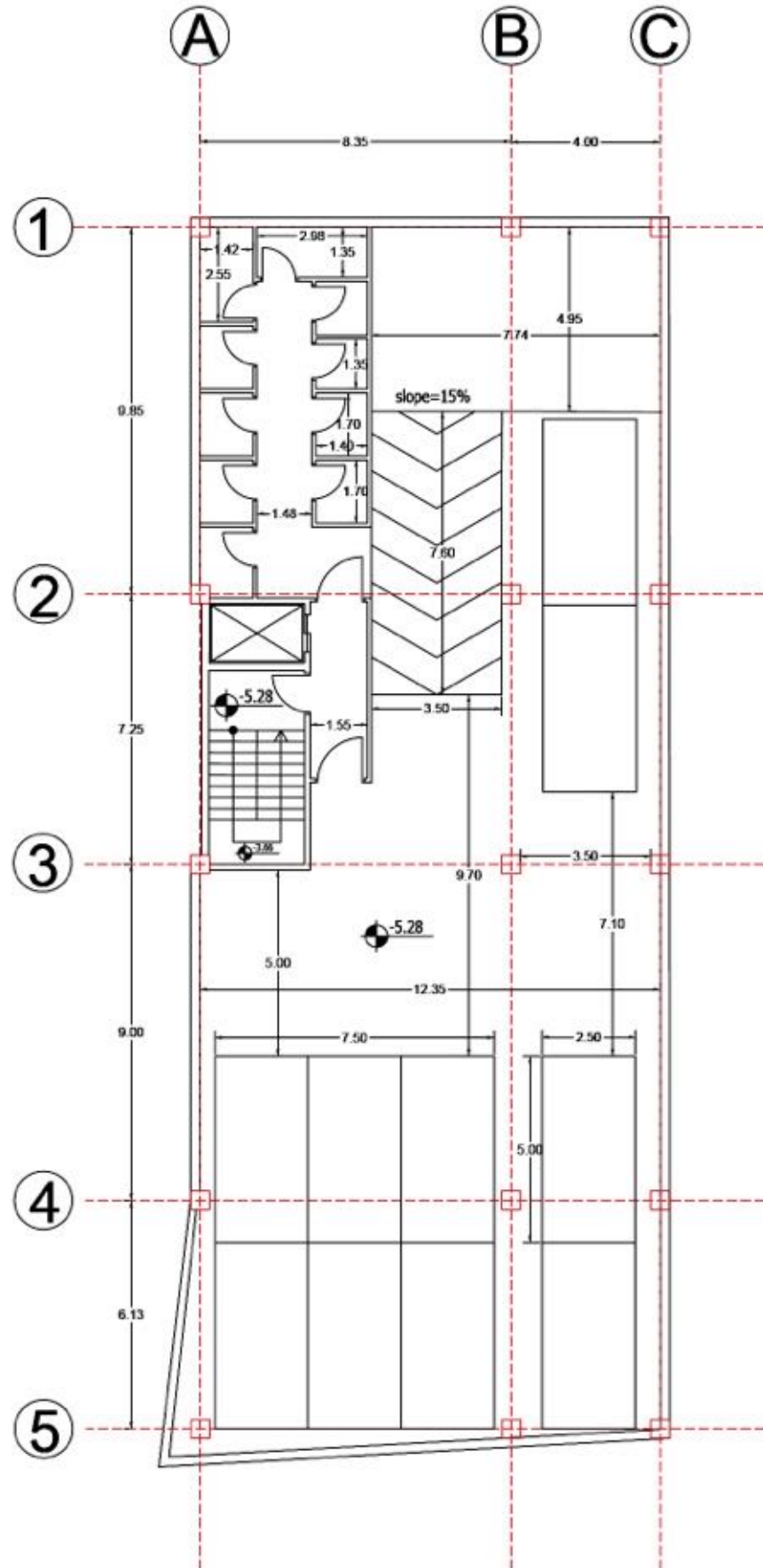

TARH 2 TARH

DOLLAT PROJECT

DESIGN BY
DELFIORÉ
ARCHITECTURE
GROUP

ARCHITECT
AMIRALI SADEGHII

SCALE:1/100

FIRST FLOOR
PLAN DIMENSIONS

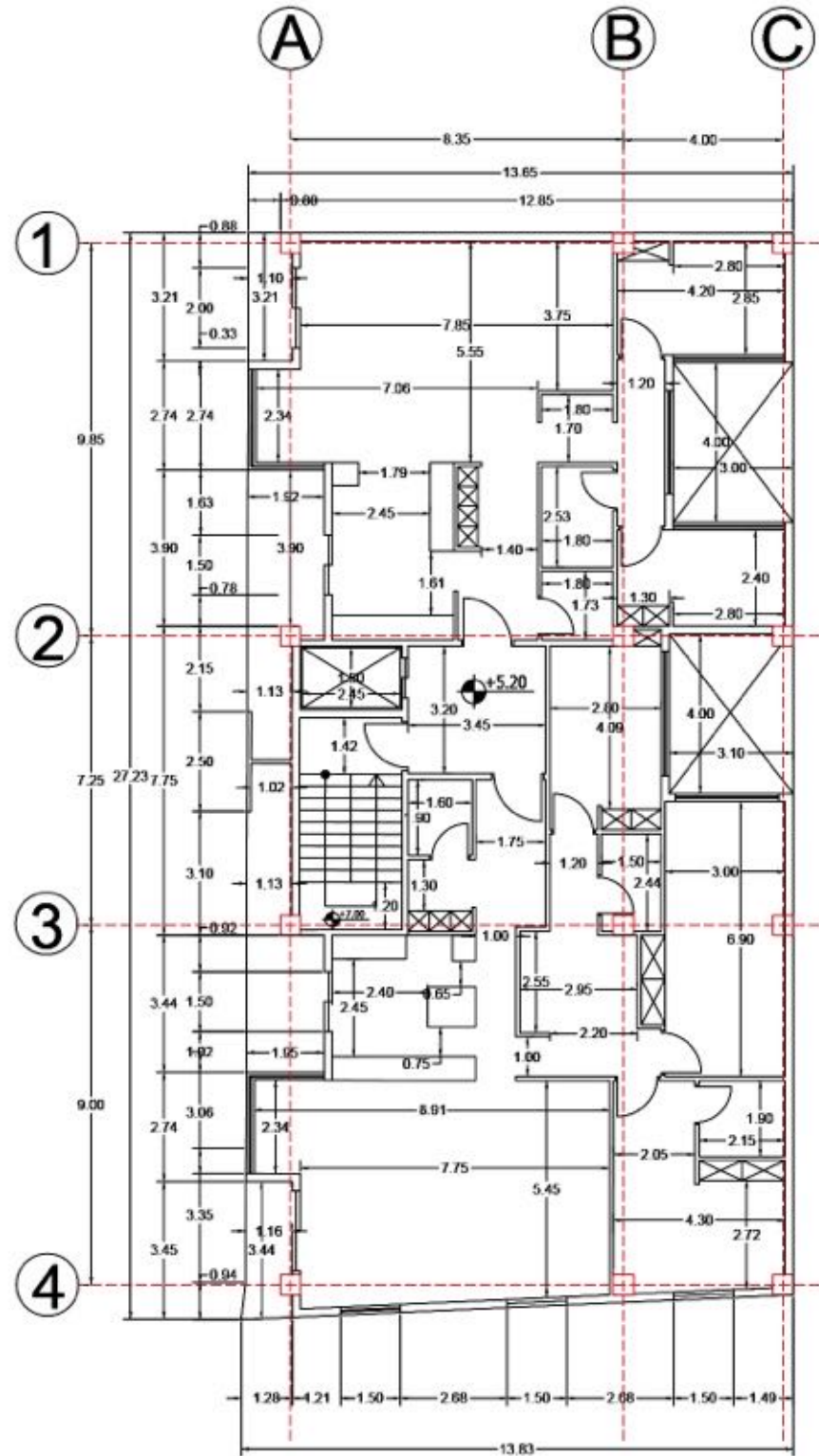

TARH 2 TARH

DOLLAT PROJECT

DESIGN BY
DELFIORÉ
ARCHITECTURE
GROUP

ARCHITECT
AMIRALI SADEGHII

SCALE:1/100

SECOND FLOOR
PLAN DIMENSIONS

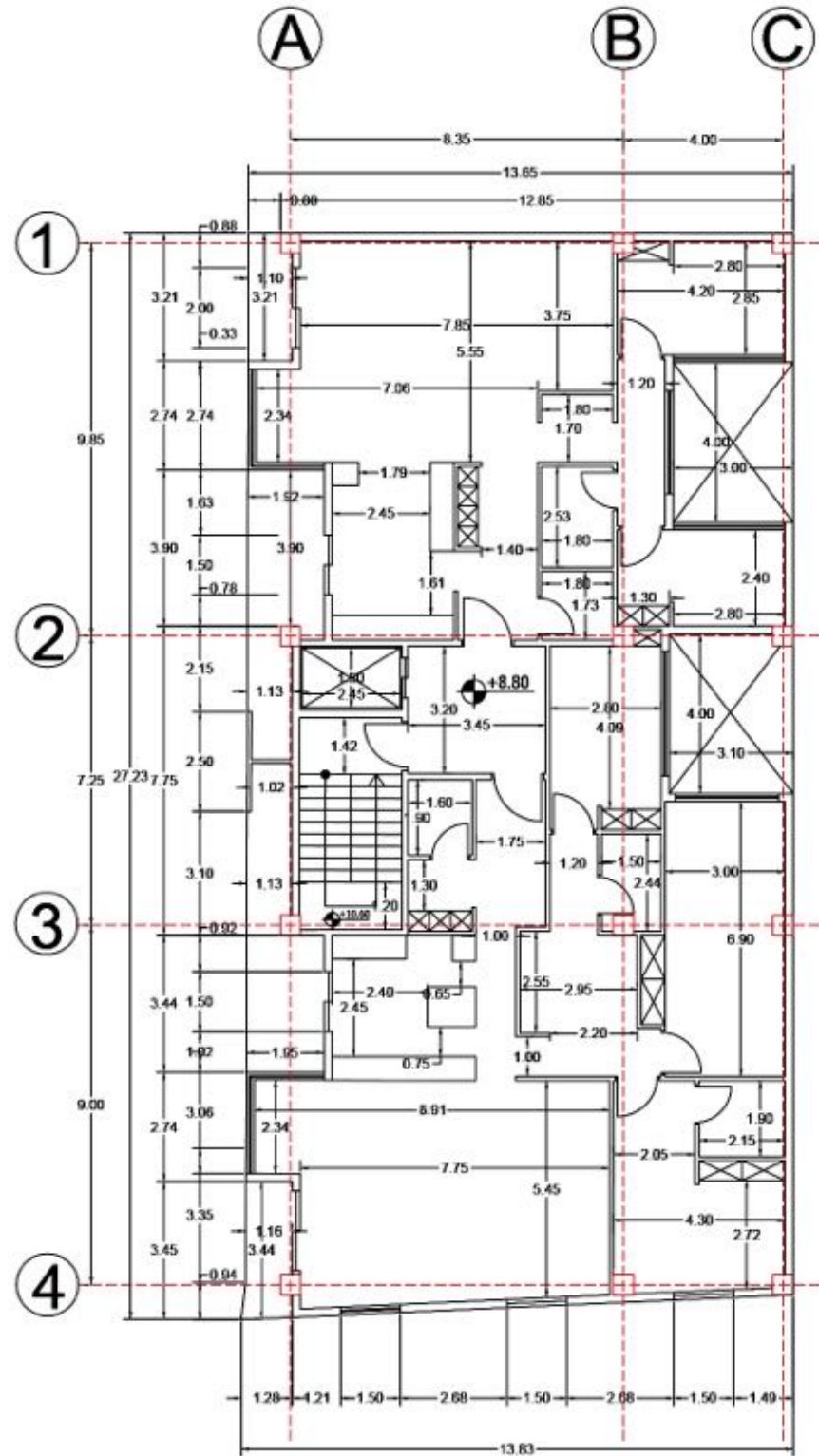

TARH 2 TARH

DOLLAT PROJECT

DESIGN BY
DELFIORÉ
ARCHITECTURE
GROUP

ARCHITECT
AMIRALI SADEGHII

SCALE: 1/100

THIRD FLOOR
PLAN DIMENSIONS

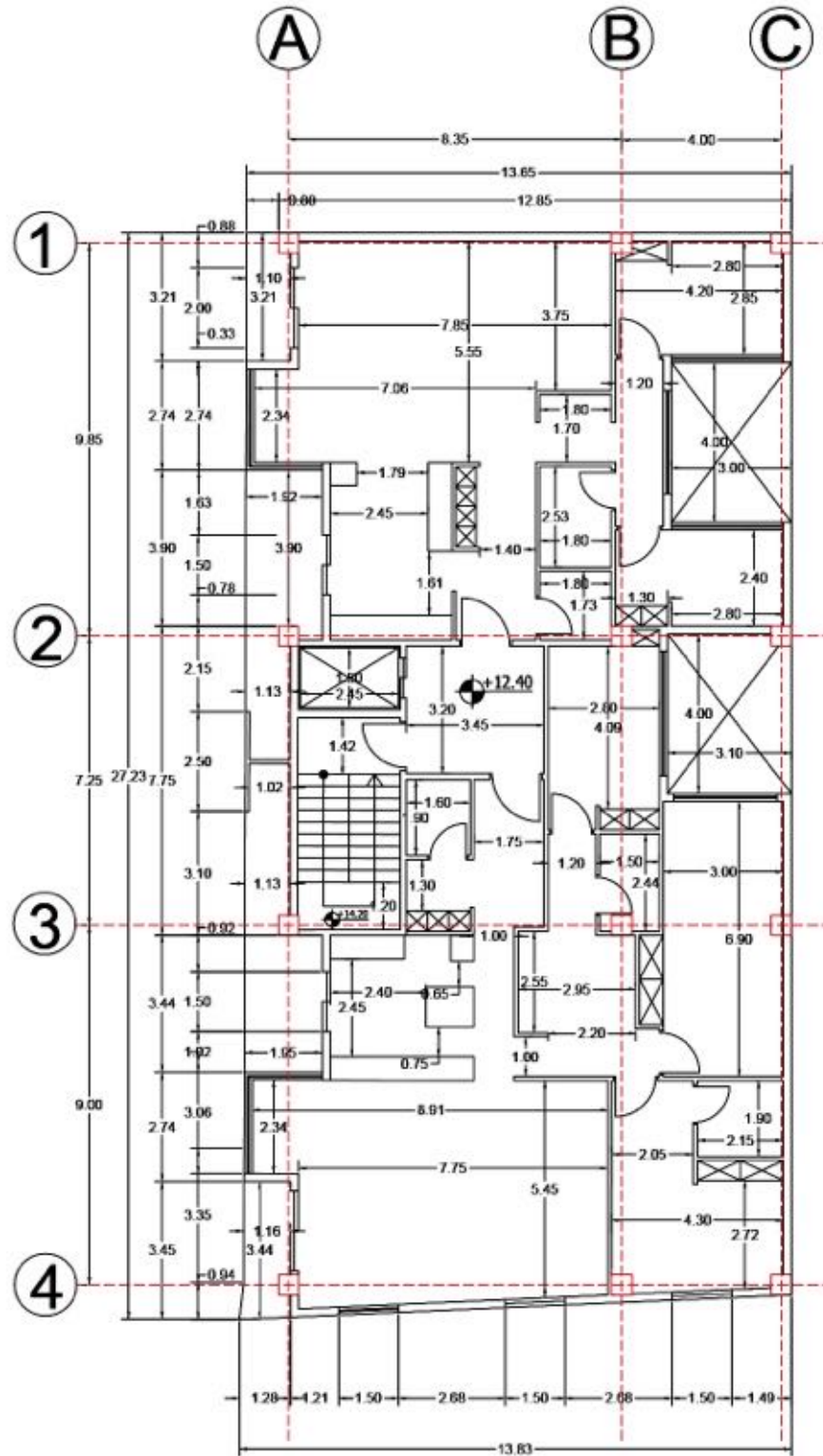

TARH 2 TARH

DOLLAT PROJECT

DESIGN BY
DELFIORÉ
ARCHITECTURE
GROUP

ARCHITECT
AMIRALI SADEGHII

SCALE:1/100

FOURTH FLOOR
PLAN DIMENSIONS

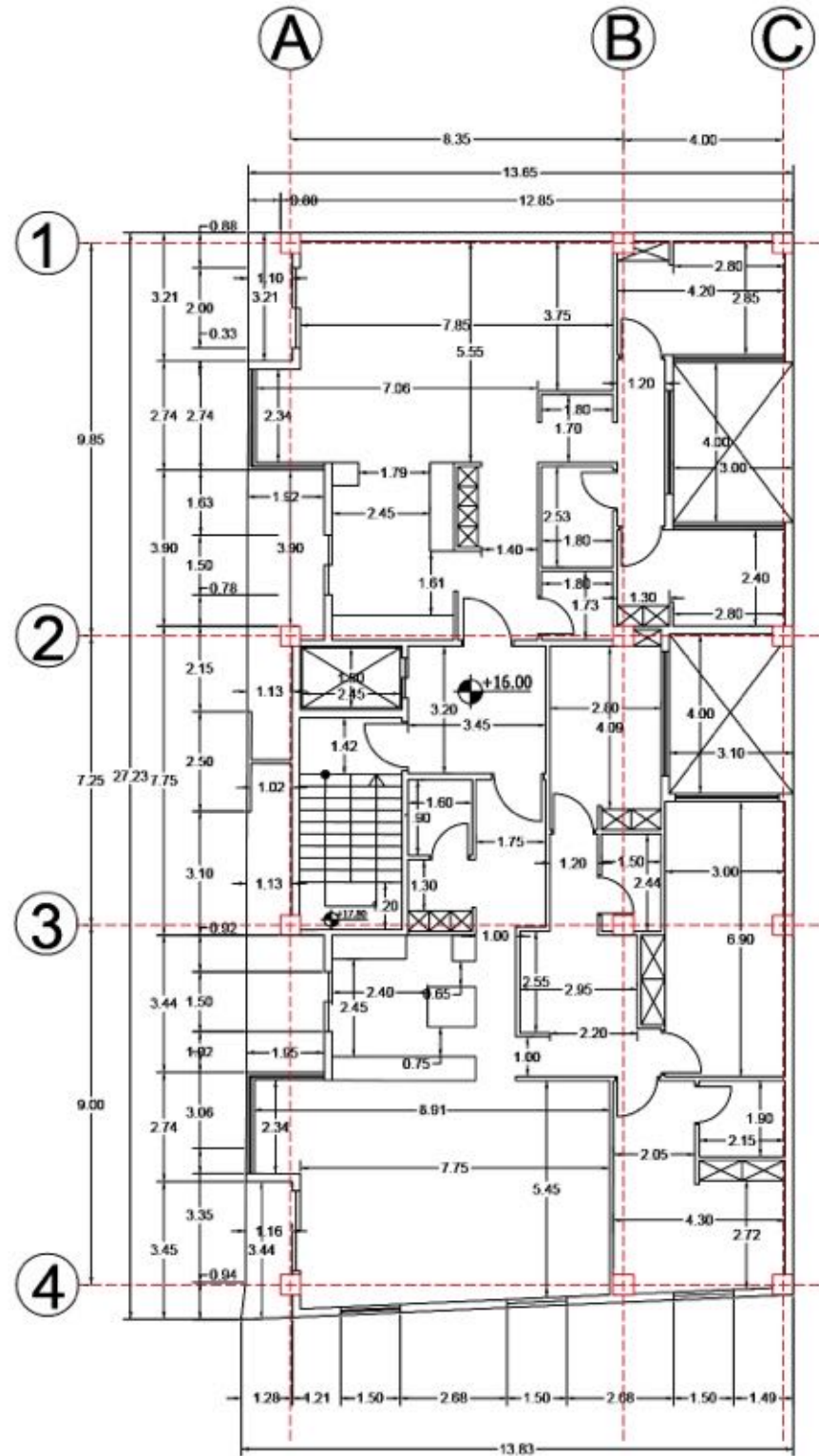

TARH 2 TARH

DOLLAT PROJECT

DESIGN BY
DELFIORÉ
ARCHITECTURE
GROUP

ARCHITECT
AMIRALI SADEGHII

SCALE:1/100

FIFTH FLOOR
PLAN DIMENTIONS

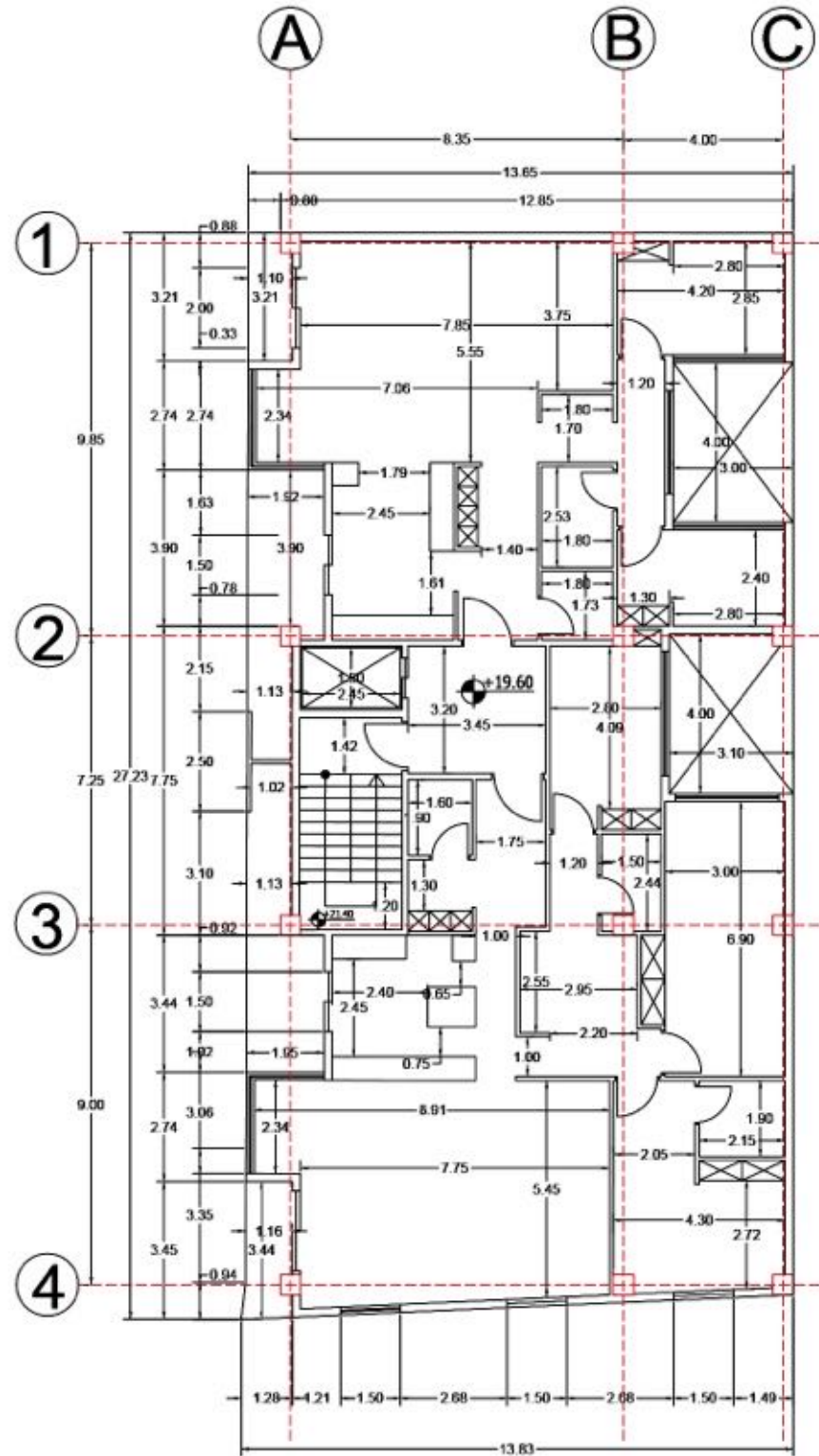

TARH 2 TARH

DOLLAT PROJECT

DESIGN BY
DELFIORÉ
ARCHITECTURE
GROUP

ARCHITECT
AMIRALI SADEGHII

SCALE:1/100

ROOF FLOOR
PLAN DIMENSIONS

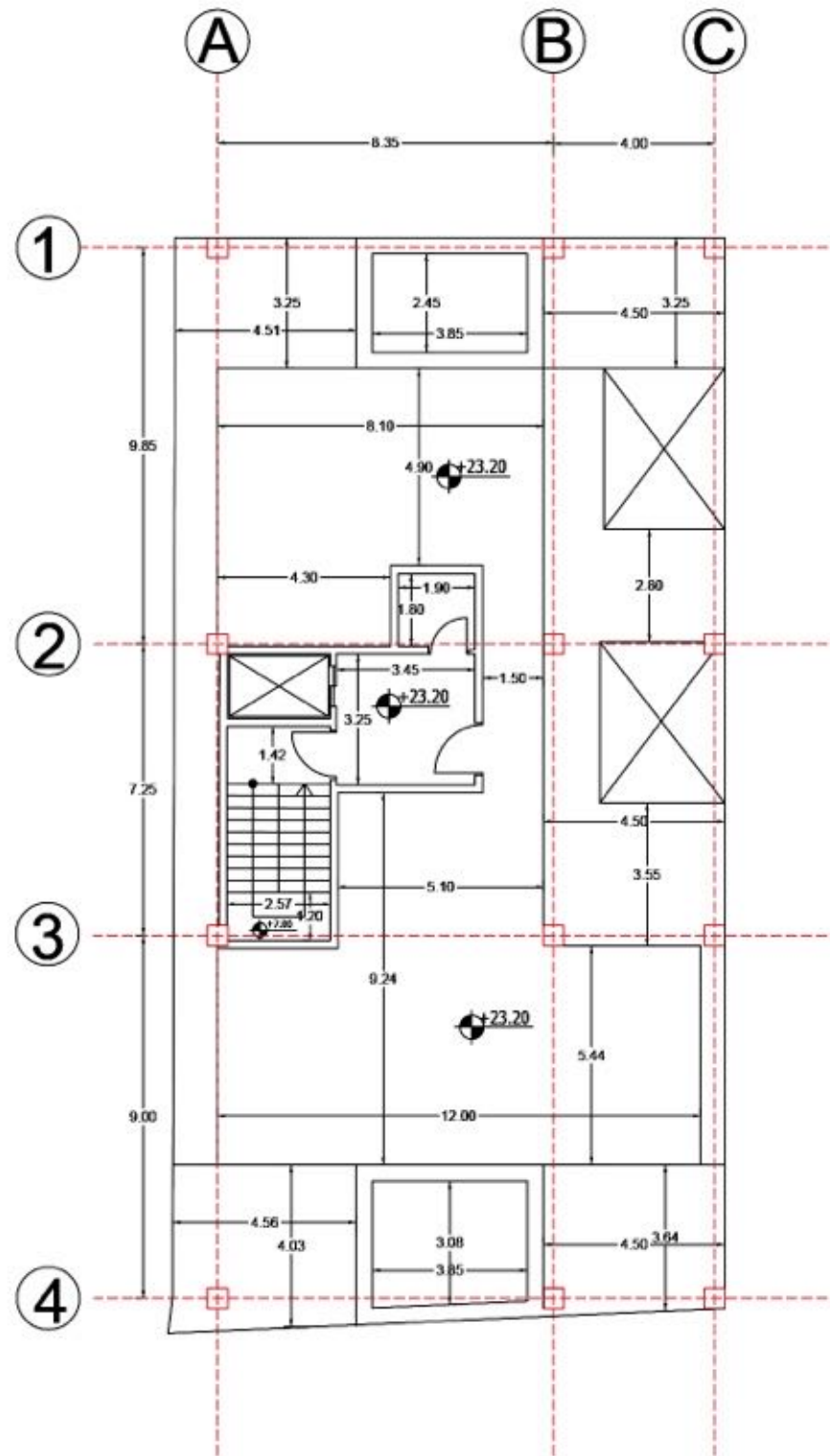

BORDERS

